

~~SECRET~~

HEADQUARTERS COMMANDER IN CHIEF U.S. PACIFIC COMMAND

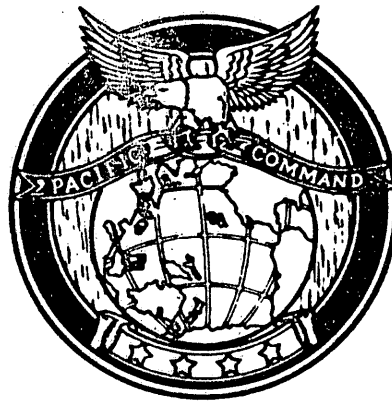

346 (11 Jan 54)

USCINCPAC RECOVERY PLAN (U)

CLASSIFIED BY CHIEF OF STAFF, HQ CINCPAC

~~FORMERLY RESTRICTED DATA~~
UNAUTHORIZED DISCLOSURE SUBJECT TO
ADMINISTRATIVE AND CRIMINAL SANCTIONS.
HANDLE AS RESTRICTED DATA IN FOREIGN
DISSEMINATION. SECTION 144b, ATOMIC ENERGY
ACT, 1954.

#6

COPY NO 1 OF 105 COPIES

JCS 25301/15

~~SECRET~~

Delessie used
again FOIA #777
2/2/87 6

~~SECRET~~

1984 JUL -2 COMMANDER IN CHIEF, US PACIFIC COMMAND
CAMP H. M. SMITH, HI 96861 1984 JUL -2 PM 2:43

32
5000
Ser S420
6104
11 June 1984

SUBJECT: USCINCPAC RECOVERY PLAN (U)
SEE DISTRIBUTION (Annex Z)

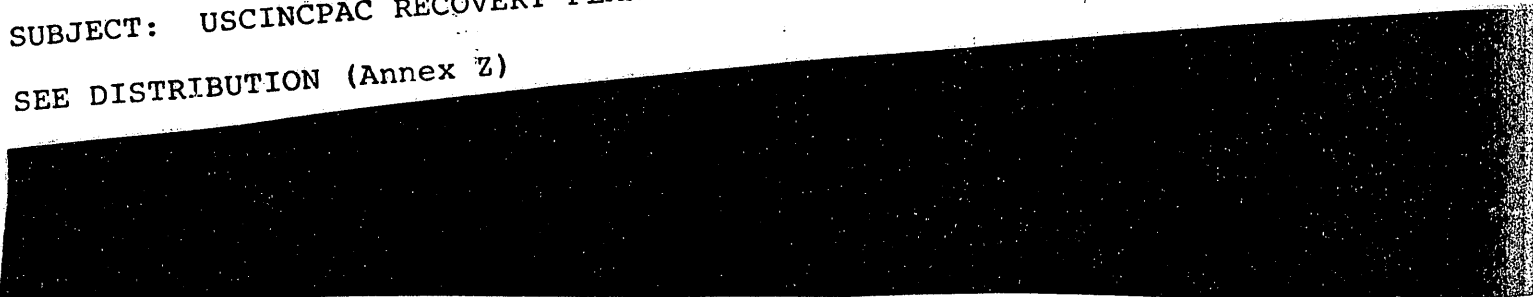

- 2. (U) This plan fulfills the supporting plan requirement of subparagraph 3d, Plan Summary, JCS RECOVERY PLAN and the requirement established in paragraph 3 Section V, Volume 1 of JSCP FY 83.
- 3. (U) This plan is effective for planning purposes only until approved by the Joint Chiefs of Staff.
- 4. (U) Supporting plans listed in subparagraph 3d, Plan Summary, will be prepared and forwarded for review within 60 days after approval of this Plan by the JCS.
- 5. (U) When separated from the Enclosure, this letter is SECRET.

FOR THE COMMANDER IN CHIEF:

Walter C. Schrupp
WALTER C. SCHRUPP
Major General, USAF
Deputy Chief of Staff

1 Encl
USCINCPAC RECOVERY PLAN (U)

CLASSIFIED BY: CHIEF OF STAFF

FORMERLY RESTRICTED DATA
Unauthorized disclosure subject to
administrative and criminal sanctions.
Handle as Restricted Data in foreign
dissemination. Section 144b, Atomic
Energy Act of 1954.

~~SECRET~~

~~SECRET~~

(THIS PAGE INTENTIONALLY LEFT BLANK)

~~SECRET~~
(this page is UNCLASSIFIED)

UNCLASSIFIED
UNCLASSIFIED

HEADQUARTERS

COMMANDER IN CHIEF, US PACIFIC COMMAND

CAMP H. M. SMITH, HI 96861

11 June 1984

USCINCPAC RECOVERY PLAN
SECURITY INSTRUCTIONS

1. The long title of this plan is USCINCPAC Plan For The Recovery of US Nuclear Weapons. The short title is USCINCPAC RECOVERY PLAN.
2. The USCINCPAC RECOVERY PLAN is classified SECRET Formerly Restricted Data. Information contained herein is considered to be of the highest sensitivity, having direct implications for US foreign policy and national security interests particularly as they relate to US and allied nuclear deterrence. Therefore, this information will be disseminated only to agencies, Services, and personnel whose official duties specifically require knowledge of the plan, including those required to develop supporting plans.
3. This document contains information affecting the national defense of the United States within the meaning of the Espionage Laws, Title 18, United States Code, Sections 793 and 794. The transmission or revelation of information contained herein, in any manner, to an unauthorized person is prohibited by law.
4. Reproduction of this document in whole or in part without permission of this headquarters is prohibited, except as required for the preparation of supporting plans.

UNCLASSIFIED
UNCLASSIFIED

~~SECRET~~
~~FORMERLY RESTRICTED DATA~~

HEADQUARTERS
COMMANDER IN CHIEF, US PACIFIC COMMAND
CAMP H. M. SMITH, HI 96861
11 June 1934

USCINCPAC RECOVERY PLAN (U)
PLAN SUMMARY (U)

1. (U) PURPOSE



b. (U) Because of operational variation and international complexity, this plan considers operations in Hawaii, the Aleutians and the Trust Territories of the Pacific Islands (TTPI), and OCONUS (outside CONUS) operations. Since no bilateral agreements exist between the United States and host-nation governments in the USPACOM with respect to nuclear weapons, major assumptions essential to complete planning and successful operations are provided. Plans will be revised, if necessary, when such agreements are completed. This plan identifies required interagency coordination and cooperation.

2. (U) CONDITIONS FOR IMPLEMENTATION

a. (U) This summary provides military decision makers a brief recapitulation of the major aspects of this plan. It is based on planning factors and estimates available at the time of preparation and subject to modification in the context of a specific contingency. The information contained herein should be reviewed and, if necessary, updated prior to use in adopting courses of action in a particular situation.

CLASSIFIED BY: DEPUTY CHIEF OF STAFF

FORMERLY RESTRICTED DATA
Unauthorized disclosure subject to
administrative and criminal sanctions.
Handle as Restricted Data in foreign
dissemination. Section 144b, Atomic
Energy Act, 1954

iii
~~SECRET~~

FORMERLY RESTRICTED DATA
Unauthorized disclosure subject to
administrative and criminal sanctions.
Handle as Restricted Data in foreign
dissemination.

USCINCPAC RECOVERY PLAN

b. (U) Recovery operations may be initiated by USCINCPAC, service components, Joint Chiefs of Staff, or the NCA. Normally, plan execution will be initiated upon receipt of an OPREP-3 PINNACLE/BROKEN ARROW report that indicates a nuclear weapon or nuclear component has been lost, seized, or stolen from USPACOM custody, facility or transport.

c. (U) Subelements of this plan, may be activated and/or deployed separately and prior to the execution of this plan by those headquarters having such authority.

d. (U) Recovery of nuclear weapons is considered a peacetime mission and should not conflict with wartime missions. This does not preclude the possibility of recovery operations during time of tension or conflict. Conflicts between recovery operations and wartime missions will be resolved as they arise and mission priorities will be determined accordingly.



f. (U) Secure communications are required for all military and US civilian elements of search and recovery operations. However, recovery operations will not be delayed due to lack of secure communications.

g. (U) Military security or recovery forces may continue "hot pursuit" (as defined in Annex C).

h. (U) Operations in Hawaii, The Aleutians and the TTPI

(1) (U) The National Military Command Center (NMCC) Operations team exercises initial command and control responsibility for military search and recovery operations conducted in the United States and Territories. In accordance with public law, control will be transferred, as soon as possible, to the Department of Justice (DOJ)/FBI, which has recovery responsibility.

(2) (U) Upon request from DOJ and in accordance with public law, military recovery forces (MRF) and technical assistance teams will be deployed by USCINCPAC or appropriate service component commander to support Department of Justice operations as a matter of the highest priority.

(3) (U) Service component commanders will implement NAIC procedures as required, and report the loss or theft of a nuclear weapon or nuclear component to USCINCPAC and the NMCC in accordance with CINCPAC Instruction 3480.6F.

(4) (U) With the exception of hot pursuit, DOJ has the final authority as to the location and timing of assault operations conducted by civil authorities. The Commander, MRF, if employed, will be responsible for planning, coordinating, and executing assault operations in support of designated DOJ agent in charge.

~~SECRET~~

USCINCPAC RECOVERY PLAN

i. (U) OCONUS Operations

(1) (U) The Department of State (DOS) has primary responsibility for the coordination of recovery operations outside the United States and its Territories. The US Ambassador to the host nation has responsibility for coordinating US recovery operations. USCINCPAC has overall responsibility for military command and control of search and recovery operations and coordination with host-nation military agencies.

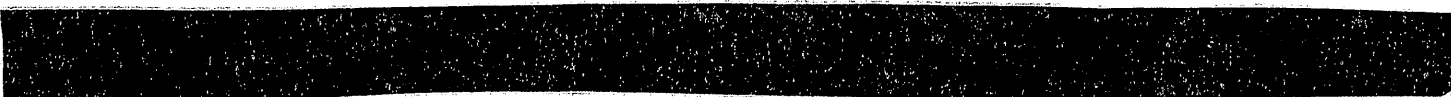

(3) (U) US military will support the host-nation forces (either civilian or military) in search and recovery operations as directed by USCINCPAC.

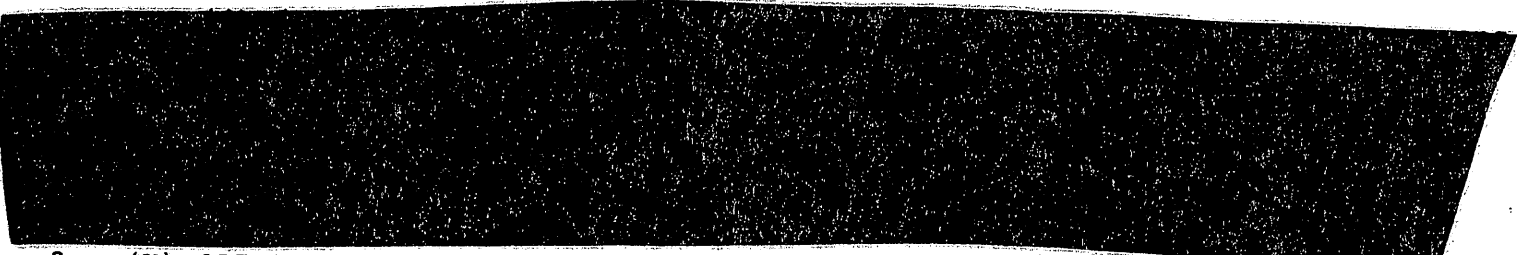

3. (U) OPERATIONS TO BE CONDUCTED

a. (U) Force Requirements. Recovery operations will be initially conducted with in-place forces (primarily surviving site security or escorting security forces and security response forces) within their capabilities. Augmentation of the forces initially attempting the recovery will be as directed by USCINCPAC or other responsible commander. Augmentation forces from outside the theater will be as directed by the Joint Chiefs of Staff based on the situation.

b. (U) Employment

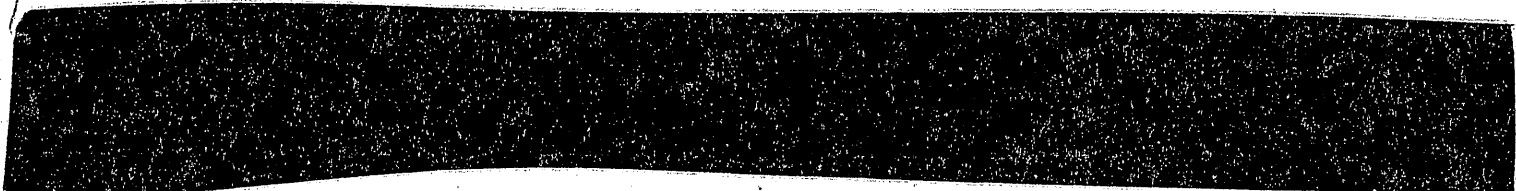

(3) (U) Use of nuclear weapons in recovery operations is not contemplated.

c. (U) Deployment. The requirement for immediate response in recovery operations makes the use of in-place forces to be the most plausible method of accomplishing the recovery mission. However, prolonged siege by the perpetrators or request for support by host-nation authorities may require deployment of specialized forces or major combat forces. The Joint Chiefs of Staff, in consultation with USCINCPAC, will direct such deployment as required by the situation.

USCINCPAC RECOVERY PLAN

d. (U) Supporting Plans. USCINCPAC subordinate commanders having custody of nuclear weapons will review, revise, or prepare supporting plans for implementation of options covered in this plan. New supporting plans or changes to existing plans or directives will be submitted to USCINCPAC within 60 days of final approval of this plan by the JCS.

4. (U) ASSUMPTIONS. The following assumptions provide rationale for the concept of this plan and will be considered in the development of supporting plans.

a. (U) Agreements with host nations will be completed and consummated by DOS wherever politically feasible.

b. (U) Interagency agreements, national and state laws, and policy will allow military assistance and support to the DOJ or host-nation forces in recovery operations.



5. (U) OPERATIONAL CONSTRAINTS



b. (U) The welfare and safety of hostages shall be considered in determining the actions to be taken. However, the presence of hostages shall not deter taking decisive, prompt, and effective action, including the use of deadly force, to recover a nuclear weapon.

6. (U) TIME TO COMMENCE EFFECTIVE OPERATIONS

a. (U) Search and recovery operations will be initiated at the earliest indication that a nuclear weapon is known or suspected of being stolen or lost.

b. (U) Initial notification and assembly of first response teams as well as crisis management teams will commence at the earliest indications of the loss. USCINCPAC and the Joint Chiefs of Staff will be notified as soon as possible of the deployment of a recovery team.



8. (U) COMSEC. Secure communications are required for all phases of the search and recovery operations. Shortfall of sufficient equipment to meet this requirement will be reported to the Joint Chiefs of Staff as soon as possible.

9. (U) COMMAND RELATIONSHIPS

a. (U) USCINCPAC will maintain operational command of committed forces in the USPACOM. Operational control of committed service search and recovery forces will be exercised in accordance with the following:

- (1) (U) In Hawaii and the Aleutians - by service component commanders.
- (2) (U) In Japan and Korea - by the appropriate subordinate unified commander.
- (3) (U) In other countries and the TTPI - by USCINCPAC.

b. (U) JTF Operations. Operational control of committed forces will be exercised by:

- (1) (U) USCINCPAC during deployment operations to the objective area.
- (2) (U) The commander, JTF, during employment in the objective area. Specific transfer of authority time and place will be as directed in the operation order directing formation of the JTF.

10. (U) LOGISTIC REQUIREMENTS. Logistic support will be provided recovery forces by the appropriate USCINCPAC service component. Special logistic requirements will be presented to USCINCPAC for resolution when they are beyond the capability of the component command and have not been able to be resolved through service channels.

11. (U) IMPLEMENTATION

a. (U) This plan or supporting plans may be implemented by Joint Chiefs of Staff, USCINCPAC, or USCINCPAC service component commander upon receipt of indications that a nuclear weapon has been lost, seized, or stolen or is in danger of such loss.

b. (U) The checklist found in Annex X represents a broad guide to the scope of necessary actions to place the plan into operation.

~~CONFIDENTIAL~~

(THIS PAGE INTENTIONALLY LEFT BLANK)

viii

~~CONFIDENTIAL~~

(This page is UNCLASSIFIED)

UNCLASSIFIED

HEADQUARTERS

COMMANDER IN CHIEF, US PACIFIC COMMAND

CAMP H. M. SMITH, HI 96861

11 June 1984

USCINCPAC RECOVERY PLAN (U)
TABLE OF CONTENTS (U)

<u>CONTENTS</u>	<u>PAGE NO.</u>
Security Instructions	i
Record of Changes	ii
Plan Summary	iii
Table of Contents	viii
Basic Plan	1
ANNEX B, INTELLIGENCE	B-1
Appendix 1, Essential Elements of Information	B-1-1
Appendix 3, Counterintelligence	B-3-1
ANNEX C, OPERATIONS	C-1
Appendix 8 - Rules of Engagement	C-8-1
Appendix 10 - Counterterrorist Operations (published separately)	
ANNEX F, PUBLIC AFFAIRS	F-1
ANNEX J, COMMAND RELATIONSHIPS.....	J-1
Appendix 1, Command Relationships-Hawaii/ Aleutians.....	J-1-1
Appendix 2, Command Relationships-Foreign coun- tries (except Japan and Korea).....	J-2-1
Appendix 3, Command Relationships-Japan and Korea.....	J-3-1
Appendix 4, Command Relationships-Trust terri- tories of the Pacific Islands.....	J-4-1
ANNEX K, COMMUNICATIONS-ELECTRONICS	K-1
Appendix 1, Communications Security	K-1-1
Tab A, USPACOM Contingency/Exercise Codes/ Keylists	K-1-A-1

CONTENTS

PAGE NO.

Tab B, USPACOM Code Systems K-1-B-1

Tab C -- USPACOM Changing Call Sign and
Frequency Systems K-1-C-1

Tab D -- USPACOM Authentication Systems K-1-D-1

Appendix 3, Diplomatic Telecommunications Service
Secure Record Communications K-3-1

Appendix 4, MRF Communications Requirements K-4-1

Tab A -- MRF Marshaling Area and ISB/Rehearsal
Area Communications K-4-A-1

Tab B -- MRF Base Communications K-4-B-1

Tab C -- MRF Objective Area Communications ... K-4-C-1

Appendix 5, USCINCPAC Crisis Situation Command and
Control Communications K-5-1

ANNEX L, OPERATIONS SECURITY L-1

Appendix 1, OPSEC Estimate L-1-1

Appendix 3, Protective Measures L-3-1

ANNEX X, EXECUTION CHECKLIST X-1

ANNEX Z, DISTRIBUTION Z-1

UNCLASSIFIED

USCINCPAC RECOVERY PLAN

(THIS PAGE INTENTIONALLY LEFT BLANK)

UNCLASSIFIED

~~SECRET~~

HEADQUARTERS
COMMANDER IN CHIEF, US PACIFIC COMMAND
CAMP H. M. SMITH, HI 96861
11 June 1984

USCINCPAC RECOVERY PLAN (U)
RECOVERY OF US NUCLEAR WEAPONS (U)

- (U) REFERENCES: (a) CINCPACINST C3480.1B
(b) JCS PUB 6
(c) CINCPAC COMPLAN 0300

(U) TASK ORGANIZATION: Situation dependent.

1. (U) SITUATION

a. (U) General

(1) (U) This plan may be executed, sequentially or concurrently, with traditional Nuclear Accident and Incident Control (NAIC) operations when directed by USCINCPAC, or appropriate USCINCPAC subordinate commander.

(2) (U) The plan considers operations in CONUS (for the purpose of this plan Hawaii, the Aleutians and TTPI are considered CONUS) and OCONUS (all other areas outside the United States and its territories). OCONUS search and recovery operational problems are compounded by international borders that afford the terrorist an opportunity to confuse, disrupt, or impede recovery operations.

b. (U) Enemy. Situation dependent.

c. (U) Friendly

(1) (U) Operations in Hawaii, the Aleutians, and Trust Territories of Pacific Islands (TTPI)

(a) (U) The National Military Command Center (NMCC) Operations Team exercises initial command and control responsibility for military search and recovery operations conducted in the United States and territories.

CLASSIFIED BY: DEPUTY CHIEF OF STAFF

FORMERLY RESTRICTED DATA

Unauthorized disclosure subject to administrative and criminal sanctions. Handle as Restricted Data in foreign dissemination. Section 144b, Atomic Energy Act of 1954.

~~SECRET~~

~~SECRET~~

USCINCPAC RECOVERY PLAN

Control of military search and recovery operations will be passed to the Department of Justice (DOJ) as soon as possible. USCINCPAC will coordinate military assistance throughout the period of operations.

(b) (U) Department of Justice (DOJ)/Federal Bureau of Investigation (FBI). In accordance with public law, DOJ/FBI is responsible for all search and recovery operations conducted in the United States and territories.

(2) (U) OCONUS Operations

(a) (U) The Department of State (DOS) has overall responsibility for coordination of recovery operations outside the United States and territories. The US Ambassador to the host nation has responsibility for coordinating US recovery operations. USCINCPAC has overall responsibility for command and control of US military search and recovery operations and coordination with host nation military agencies when appropriate.

(b) (U) The US Ambassador(s) in the country or countries involved will:

1. (U) Obtain necessary rights, authorization, and facility requirements necessary for implementation of this plan.

2. (U) Provide Diplomatic Telecommunications Service (DTS) as required.

3. (U) Conduct contingency planning in coordination with USCINCPACREPS/UNITED STATES DEFENSE REPRESENTATIVES and subordinate unified commanders to insure integrated action under this plan.



(4) (U) Defense Nuclear Agency. Provide nuclear weapons technical support as required.

(5) (U) National Security Agency/Central Security Service (NSA/CSS). Provide technical support and specialized equipment when directed by the NCA.

(6) (U) Defense Intelligence Agency. Provide intelligence support to USCINCPAC with emphasis on identification of potential nuclear weapon terrorists when directed by the NCA.

(7) (U) Defense Communications Agency. Provide DCS access, extension, interface engineering and other DCS Support when directed by the NCA.

~~SECRET~~
~~RESTRICTED DATA~~

~~SECRET~~

(8) (U) Military Airlift Command. Provide airlift for intratheater and intertheater airlift for search and recovery forces and equipment conducting recovery operations when directed by the JCS.



d. (U) Coordinating Instructions

(1) (U) Direct liaison is authorized between component commands, agencies and departments during both planning and execution phases of recovery operations. USCINCPAC will be kept informed of all coordination with other commands.



e. (U) Operational Constraints

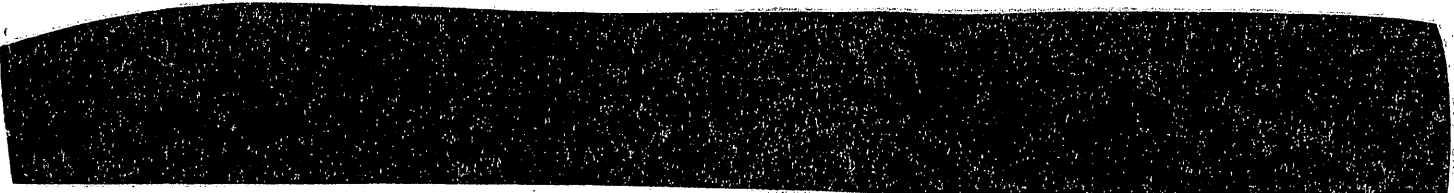

(2) (U) The welfare and safety of hostages will be considered in determining the actions to be taken. However, the presence of hostages will not deter taking decisive, prompt, and effective action, including the use of deadly force, to recover a nuclear weapon.

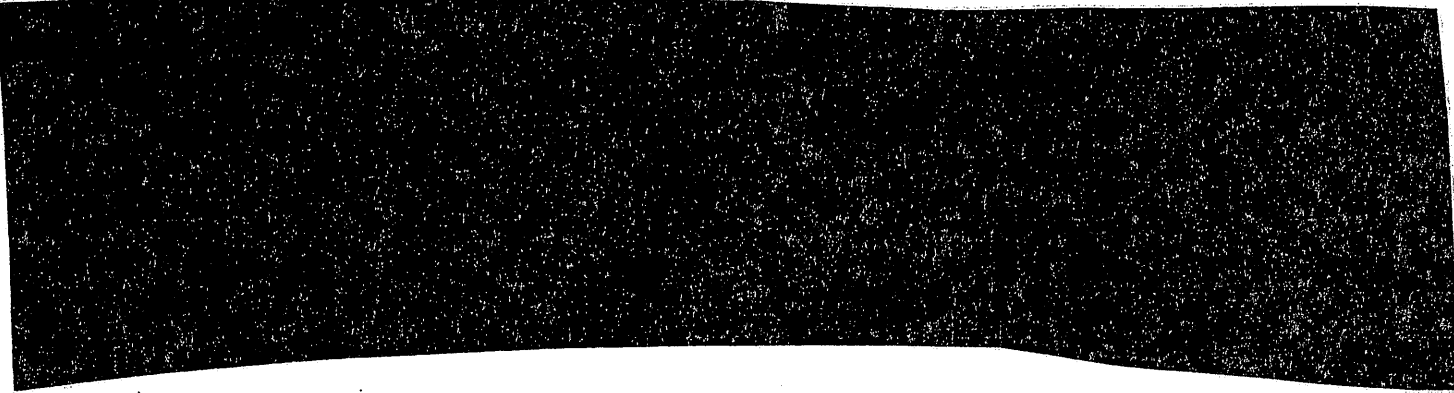

~~SECRET~~
~~RESTRICTED~~

USCINCPAC RECOVERY PLAN

f. (U) Assumptions

- (1) (U) Agreements with host nations will be completed in accordance with the provisions of this plan.
- (2) (U) The President will direct unilateral recovery operations using US forces if host nation opts not to conduct recovery operations.
- (3) (U) The Department of Defense will render maximum assistance to other agencies and host nations in the conduct of search and recovery operations.
- (4) (U) Highest priority will be given to the operation during peacetime.

g. (U) Legal Considerations

- (1) (U) "Posse Comitatus" does not apply to the recovery of nuclear weapons in hot pursuit situations.
- (2) (U) The Federal police powers of the Department of Defense and DOD Directive 5200.8 do apply to search and recovery operations in CONUS.



3. (U) EXECUTION

a. (U) Concept of Operations. The concept of operations for CONUS operations is predicated on existing nuclear accident and incident response procedures and organizations. When a seizure, theft or loss occurs, an OPREP-3 PINNACLE/BROKEN ARROW report will be forwarded to the NMCC and USCINCPAC as indicated in reference (a) by the most expeditious means.

(1) (U) General. In accordance with reference (b), initial notification of an incident requiring recovery operations will be made to the Chairman, Joint Chiefs of Staff; Secretary of Defense; White House; Services; DOE; DOJ; DOS and USCINCPAC.

(a) (U) The service component commander having custody of the weapon(s) at the time of loss or theft will alert, activate, and deploy all resources capable of recovering or locating and maintaining surveillance of the stolen weapon. Additionally, local site support plans will be activated at the discretion of the site commander.

(b) (U) Command and control for the conduct of recovery operations will be in accordance with Annex J.



(2) (U) Employment. Surviving security and escort forces, along with any response forces, in accordance with DOD Directive 5210.41 and DOD 5210.41-M will pursue and maintain contact with forces and individuals who have possession of a stolen nuclear weapon. Forces in hot pursuit are authorized to use the amount of force required to regain US custody of the weapon. Use of nuclear weapons and lethal chemical agents are not envisioned for this plan. Commanders will use all supporting operations deemed appropriate, commensurate with time available for implementation; such as PSYOP, EW, and deception.

(3) (U) Deployment

(a) (U) Intratheater and intertheater deployment of major combat forces is not expected for recovery operations because of the requirement to take immediate military action to recover stolen nuclear weapons.

(b) (U) Depending on the situation, specialized forces and equipment such as described in reference (c) may be required to support the commander effecting recovery.

(c) (U) Intratheater assets will be used when available.

(d) (U) Intertheater assets made available through the Joint Chiefs of Staff.

b. (U) Tasks

(1) (U) CINCPACFLT

(a) (U) Is responsible for the security and recovery of nuclear weapons from PACFLT ships and storage facilities.

(b) (U) Provide notification of loss or theft of nuclear weapons from their custody.

~~SECRET~~

(c) (U) Provide hot pursuit within existing capabilities.

(d) (U) When directed, provide forces with the following capabilities to support DOJ and/or DOS recovery operations in the USPACOM.

1. (U) Command and Control capability from 7th Fleet.
2. (U) EOD, divers, and helicopter support as required.
3. (U) Security forces for protection of NEST operations.

(e) (U) Provide planning support to USCINCPAC as required.

(f) (U) Provide administrative and logistical support for PACFLT forces.

(2) (U) CINCPACAF

(a) (U) Is responsible for the security and recovery of nuclear weapons from PACAF facilities.

(b) (U) Provide notification of loss or theft of nuclear weapons from their custody or protection.

(c) (U) Provide hot pursuit within existing capabilities.

(d) (U) When directed, provide forces with the following capabilities to support DOJ and/or DOS recovery operations in the USPACOM.

1. (U) Airborne Command Post Support.
2. (U) EOD and helicopter support as required.
3. (U) Security forces for protection of NEST operations.

(e) (U) Provide planning support to USCINCPAC, as required.

(f) (U) Provide administrative and logistical support for PACAF forces.

(3) (U) CDRWESTCOM

(a) (U) When directed, provide US Army forces and equipment in support of other commands conducting search and recovery operations.

(b) (U) Provide planning support to USCINCPAC as required.

(c) (U) Provide administrative and logistical support for WESTCOM forces.

~~SECRET~~

(4) (U) COMUSKOREA/COMUSJAPAN

(c) (U) Provide administrative and logistical support for their respective forces.

4. (U) ADMINISTRATIVE AND LOGISTICSa. (U) Concept of Logistic Support

(1) (U) The military services will provide logistic support using peacetime procedures in accordance with service directives.

(2) (U) Search and recovery forces will normally be transported by airlift.

(3) (U) Logistic planning should anticipate supporting search and recovery forces for an indefinite period.

(4) (U) Full access to national resources will assure that all supply requirements are met.

(5) (U) Inter-service support requirements are situation dependent and will be identified by USCINCPAC when deployment begins.

b. (U) Assumptions

(1) (U) Required specialized equipment and supplies will be readily available.

(2) (U) Deployment routes, transit rights and overflight authorizations will remain available as during any peacetime operations.

c. (U) Medical Services. Casualties or seriously ill will be evacuated directly from the objective area or safehaven to intermediate and/or CONUS medical installations for hospitalization.

d. (U) Personnel

(1) (U) Personnel policies and procedures to support this plan will be in accordance with applicable service directives.

USCINCPAC RECOVERY PLAN

~~SECRET~~

(2) (U) Detailed planning should provide clear guidelines for disposition of prisoners of war, civilian internees and other detained persons. General guidance for processing detained persons is contained in CINCPACINST 3461.3A.

e. (U) Public Affairs. Annex F.

f. (U) Civil Affairs. Not applicable.

g. (U) Environmental Services. Service component commands should plan to alert and utilize their own meteorological and oceanographic service organizations upon implementation of this plan.

h. (U) Mapping, Charting and Geodesy. Not applicable.

5. (U) COMMAND AND SIGNAL

a. (U) Command Relationships. Annex J.

b. (U) Command Posts (CPs). Initial locations will be the peacetime CP locations. Operational CP locations will be dictated by the individual weapon search and recovery scenario.

c. (U) Succession to Command. Situation dependent.

d. (U) Communications and Electronics. Annex K.

WILLIAM J. CROWE
Admiral, U. S. Navy
Commander in Chief

Annexes:

- B INTELLIGENCE
- C OPERATIONS
- F PUBLIC AFFAIRS
- J COMMAND RELATIONSHIPS
- K COMMUNICATIONS-ELECTRONICS
- L OPERATIONS SECURITY
- X EXECUTION CHECKLIST
- Z DISTRIBUTION

OFFICIAL:



WALTER C. SCHRUPP
Major General, USAF
Deputy Chief of Staff

~~SECRET~~

(This page is UNCLASSIFIED)

~~CONFIDENTIAL~~
HEADQUARTERS
COMMANDER IN CHIEF, US PACIFIC COMMAND
CAMP H. M. SMITH, HI 96861
11 June 1984

ANNEX B TO USCINCPAC RECOVERY PLAN (U)
INTELLIGENCE (U)

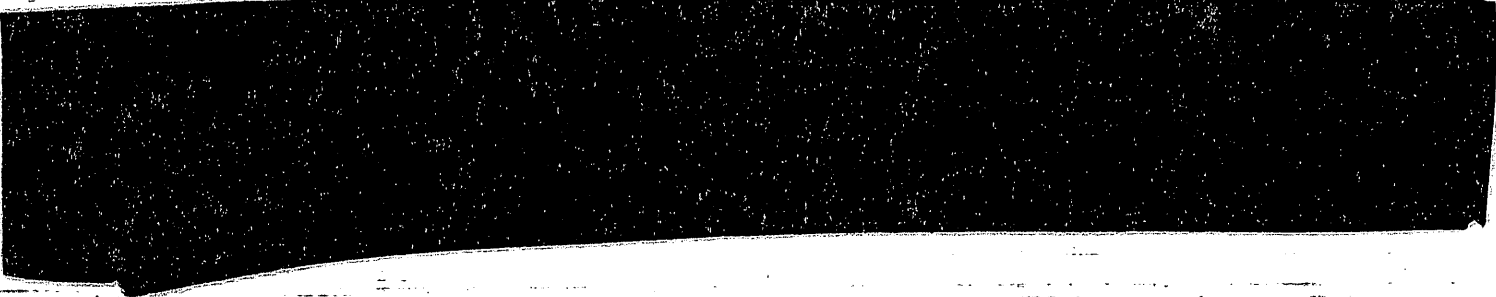

WILLIAM J. CROWE, JR.
Admiral
Commander In Chief

Appendices:

- 1 - Essential Elements
- 3 - Counterintelligence

OFFICIAL:

Jimmy C. Pettyjohn

JIMMY C. PETTYJOHN
Brigadier General
Director, J-2

CLASSIFIED BY: DEPUTY CHIEF OF STAFF
DECLASSIFY ON: OADR

~~CONFIDENTIAL~~

USCINCPAC RECOVERY PLAN

(THIS PAGE INTENTIONALLY LEFT BLANK)

B-2

~~CONFIDENTIAL~~

(This page is UNCLASSIFIED)

~~SECRET~~

HEADQUARTERS
COMMANDER IN CHIEF, US PACIFIC COMMAND
CAMP H. M. SMITH, HI 96861
11 June 1984

APPENDIX 1 TO ANNEX B TO USCINCPAC RECOVERY PLAN (U)
ESSENTIAL ELEMENTS OF INFORMATION (U)

- (U) REFERENCES: (a) Continuing Intelligence Requirement, D-DC4-42557,
29 January 1982, Critical Unusual Situation-Terrorism.
(b) Continuing Intelligence Requirement, K-OS1-00046.

1. (U) GENERAL. The purpose of this appendix is to identify requirements for essential elements of information (EEI) for execution of the planned operation. Information pertaining to EEI will be reported by any individual with the knowledge. These EEI are considered supplemental to those listed in references (a) and (b).

2. (U) BEFORE IMPLEMENTATION OF THE PLAN. The following is a partial listing of EEI requiring fulfillment prior to execution. EEI indicated have been stated in terms of potential requirement to assist intelligence collecting agencies in formulating their procedures to satisfy the EEI. It should be noted that the list of EEI is not inclusive and may be expanded. Prompt action to satisfy these EEI is essential to successful recovery of nuclear weapons.

CLASSIFIED BY: DEPUTY CHIEF OF STAFF
DECLASSIFY ON: OADR

B-1-1

~~SECRET~~

~~SECRET~~3. (U) UPON IMPLEMENTATION OF THE PLAN

- a. (U) Who were the perpetrators? How many were involved?
- b. (U) What weapons, tactics, etc., were used?
- c. (U) When do they plan to move the nuclear material/weapon?
- d. (U) How do they plan to move it?
- e. (U) What will it be used for? What purpose will its use serve? What time-line will serve this purpose?
- f. (U) Where is it? Where will it be used?
- g. (U) How it is secured? By how many? With what weapons?
- h. (U) How is it stored?
- i. (U) What are the access, terrain, and physical security factors of location where weapon is hidden?

~~SECRET~~

~~SECRET~~

HEADQUARTERS
COMMANDER IN CHIEF, US PACIFIC COMMAND
CAMP H. M. SMITH, HI 96861
11 June 1984

APPENDIX 3 TO ANNEX B TO USCINCPAC RECOVERY PLAN (U)
COUNTERINTELLIGENCE (U)

- (U) REFERENCES:
- (a) Executive Order 12333, 4 December 1981, United States Intelligence Activities.
 - (b) DOD Directive 5240.1, 3 December 1982, Activities of DOD Intelligence Components That Affect U.S. Persons.
 - (c) DOD 5240.2, 18 December, Intelligence Components that Affect U.S. Persons.
 - (d) DOD Directive 5240.2, 18 December 1979, Department of Defense Counterintelligence.
 - (e) SM-496-81, 22 July 1981, Counterintelligence Responsibilities.
 - (f) Defense Intelligence Agency Regulation #54-5, 13 August 1980, Counterintelligence, DIA Counterintelligence.

1. (U) GENERAL

a. (U) The purpose of this appendix is to establish procedures concerning the conduct of counterintelligence (CI) and security activities in support of the military operations outlined in this plan (references (a) through (f) apply).



c. (U) Coordination of CI activities will be effected between DOD activities and Department of Justice (DOJ) for CONUS operations and between the Department of Defense and Department of State (DOS) and commander of the appropriate unified command for OCONUS (outside CONUS) operations. USCINCPAC, service component commanders, or DOJ (CONUS operations) and DOS/host nation (OCONUS operations) will designate, initiate, and coordinate all actions required to insure that CI collection capabilities within the area of operations are used to the maximum extent.



~~SECRET~~

~~SECRET~~

[REDACTED]

2. (U) HOSTILE THREAT. The threat to a specific recovery operation cannot be determined in advance. Likely individuals, groups, or organizations will be identified in current Intelligence Estimates.

3. (U) COUNTERINTELLIGENCE ORGANIZATIONS AND UNITS

[REDACTED]

c. (U) NMCC will coordinate DOJ/DOS request for CI personnel augmentation teams in CONUS and OCONUS.

4. (U) COUNTERINTELLIGENCE PLANS, ACTIVITIES, AND FUNCTIONS

a. (U) CONUS operations. Assigned and supporting CI elements will contribute to the recovery of a lost or stolen nuclear weapon(s) through:

(1) (U) Aggressive CI collection operations and defensive CI activities against the multidiscipline CI and terrorist collection threat.

(2) (U) Assessments of the terrorist threat and potential for use of a stolen nuclear weapon(s).

(3) (U) Collection, evaluation, and dissemination of information concerning threats and incidents related to the security of special nuclear materials.

[REDACTED]

b. (U) OCONUS Operations. Director, DIA, will provide:

[REDACTED]

~~SECRET~~

[REDACTED]

5. (U) COUNTERINTELLIGENCE TARGETS AND REQUIREMENTS

[REDACTED]

6. (U) COORDINATION

[REDACTED]

b. (U) Friendly Nations. CI elements will assist civil and military organizations of the host nation in which the search is being conducted. CI personnel must observe local laws and diplomatic agreements between the United States and the host nation, and must be alert to the presence of anti-nuclear groups that could act as an impediment to operations forces.

c. (U) Neutral Nations. CI elements and personnel must comply with laws of the nation concerned and any US/host nation agreements.

[REDACTED]

7. (U) MISCELLANEOUS

a. (U) Special Reports. Will be submitted in accordance with directives set forth by command and control elements.

~~SECRET~~

USCINCPAC RECOVERY PLAN

b. (U) Intelligence Funds. When required, requests will be submitted through parent-Service CI channels, with information copies to the Crisis Action Team.



~~SECRET~~

FORMERLY RESTRICTED DATA

HEADQUARTERS
COMMANDER IN CHIEF, US PACIFIC COMMAND
CAMP H. M. SMITH, HI 96861
11 June 1984

ANNEX C TO USCINCPAC RECOVERY PLAN (U)
OPERATIONS (U)

1. (U) GENERAL

b. (U) Mission. See Basic Plan.

c. (U) Alliance Plans. Not applicable.

2. (U) CONCEPT OF OPERATIONS. Search and recovery operations are logical extensions of USCINCPAC's and Service's safeguarding responsibilities. Forces described in this plan, and CINCPAC CONPLAN 0300, possess the capability to locate and recover a stolen US nuclear weapon from a hostile force as well as the capability to locate and recover a US nuclear weapon which has been lost from US custody through an accident or inadvertent jettison. Such operations are characterized by four distinct phases -- nuclear accident and incident control (NAIC) reporting, search operations, assault/recovery operations and post recovery operations. This plan will not cover the assault phase in that

CLASSIFIED BY: DEPUTY CHIEF OF STAFF
FORMERLY RESTRICTED DATA
Unauthorized disclosure subject to
administrative and criminal sanctions.
Handle as Restricted Data in foreign
dissemination. Section 144b, Atomic
Energy Act, 1954.

~~SECRET~~

USCINCPAC RECOVERY PLAN

such operations are governed by other plans. Only post recovery operations need be conducted sequentially to the other phases. It is envisioned that more than one search and recovery operation may occur simultaneously and in different locations. Therefore, component commanders must consider the need to conduct multiple operations simultaneously.

a. (U) Phase I - Reporting

(1) (U) Theft, seizure, or loss of nuclear weapons is categorized as a nuclear weapon accident. Immediate reaction to such accidents is the primary responsibility of the commander or service having custody of the installation where the weapons are stored or the commander responsible for providing protection for the weapons while on his installation during logistic movement.

(2) (U) Seizure, theft, or loss of US nuclear weapons will be reported as an OPREP-3 PINNACLE/BROKEN ARROW in accordance with JCS PUB 6.

(3) (U) The NCA will be notified immediately through the National Military Command Center (NMCC) whenever a recovery action is initiated. Further, the Federal Bureau of Investigation (FBI), DOE, DOS, and possibly local authorities will be notified if recovery actions are required in the United States. If loss occurs in a foreign country, the US Ambassador in the host nation or countries involved will be notified expeditiously by USCINCPAC.

b. (U) Phase II - Search Operations



(2) (U) Deception operations may be planned to support specific search operations.

c. (U) Phase III - Assault and Recovery Operations. Assault and recovery operations are not specifically addressed by this plan. Other plans containing specific details of such operations have been approved and should be considered in conjunction with this plan when planning for assault and recovery operations. General requirements for assault and recovery plans should include:

(1) (U) Recovery forces are required to establish and maintain secure two-way contact with a facility having continuous secure communications with USCINCPAC and the NMCC. However, inability to communicate will not inhibit commencement of recovery operations.

~~SECRET~~

(3) (U) The welfare and safety of hostages will be considered in determining the actions to be taken. However, the presence of hostages will not deter the Military Recovery Force (MRF) from taking decisive, prompt, and effective action, including the use of deadly force, to recover a nuclear weapon.

(5) (U) Recovery operations for nuclear weapons which have been lost, seized or stolen from US ships will be conducted in accordance with the following:

d. (U) Phase IV - Post recovery Operations. These plans are initiated once the weapon has been recovered.

(1) (U) Under most circumstances, the recovery force will have nuclear-qualified explosive ordnance disposal (EOD) personnel. In the other situations, nuclear qualified EOD personnel must be made available from component forces.

(2) (U) At the conclusion of the assault operation and upon notification of the recovery force commander that assault operations are completed, nuclear qualified EOD personnel will examine the nuclear weapon to determine its condition and to ascertain if the weapon is safe to transport.

(3) (U) If required, the EOD personnel may render the weapon safe so that it may be transported by the most expeditious means to a location designated by the controlling headquarters. Such locations will be, when possible, an approved military or DOE nuclear weapons storage site.

(4) (U) If questions of safety are raised by EOD personnel, DOE may be requested to provide technical assistance. After render safe has been completed, the weapon(s) will be transported to CONUS where custody will be transferred from the Department of Defense to DOE for further disposition.

3. (U) CONDUCT OF OPERATIONS

a. (U) Readiness, Alert, and Marshaling. Situation dependent.

b. (U) Air Operations

~~SECRET~~

USCINCPAC RECOVERY PLAN

c. (U) Aerospace/Air Defense Operations. USCINCPAC, in conjunction with host nations, will plan for the identification, tracking, and if directed, the interception of military/civilian aircraft suspected of carrying stolen nuclear weapons to prevent entry into countries preventing recovery operations. If time allows, such decisions should be made in coordination with the US ambassador and host nation in the area of operation.

d. (U) Amphibious Operations. Not used.

e. (U) Antisubmarine Warfare Operations. Not used.

f. (U) Command, Control, and Communications Countermeasures. Situation dependent. Plans will be based on threats in applicable area of operations.

g. (U) Counterinsurgency. Not used.

h. (U) Nuclear Operations. Nuclear options are not contemplated for this plan.

i. (U) Chemical Warfare. Not used.

j. (U) Electronic Warfare. Not used.

k. (U) Psychological Operations. Not used.

l. (U) Unconventional Warfare. Not used.

m. (U) Search and Recovery Operations. Not used.

n. (U) Deception. Not used.

C-5

~~SECRET~~
FORMER RESTRICTED DATA

~~SECRET~~

- 8. (U) Rules of Engagement. Appendix 8.
- 9. (U) Reconnaissance. Not used.
- 10. (U) Counterterrorist Operations. Covered by CINCPAC CONPLAN 0300.



WILLIAM J. CROWE, JR.
Admiral
Commander in Chief

Appendices:
1. Rules of Engagement

OFFICIAL:

[Handwritten Signature]
JOHN W. COX
Major General
Director, J-3

C-6
~~SECRET~~
FORMERLY RESTRICTED DATA

SECRET

CLASSIFIED BY: DEPUTY CHIEF OF STAFF
DECLASSIFY ON: OADR

(a) (U) Recovery operations are divided into four phases - (1) nuclear accident and incident control (NAIC) reporting and notification, (2) search operations, (3) assault and recovery operations, and (4) post recovery operations. This plan does not address assault operations, which are covered by CINCPAC COMPLAN 0300.

(1) (U) General

a. (U) Concept of Operations

3. (U) EXECUTION

2. (U) MISSION. Standing USCINCPAC ROE contained in reference (a), ROE herein, and supplemental ROE published to support any options executed, are intended to avoid provocation, to limit force to that necessary to accomplish the mission, and to provide protection for US lives and property. Nothing in these ROE is intended to deprive a commander, at any level, of his inherent right to self-defense nor alter his responsibility for the security of his command and the accomplishment of his mission.

d. (U) Assumption. Upon execution of this plan, supplemental rules of engagement (ROE) will be promulgated by USCINCPAC, if required.

c. (U) Friendly. Situation dependent.

b. (U) Enemy. Annex B.



1. (U) SITUATION

REFERENCE: (a) USCINCPACINST S3710.2D, 31 Dec 81, USPACOM Peacetime Rules of Engagement (ROE)

APPENDIX 8 TO ANNEX C TO USCINCPAC RECOVERY PLAN (U)
RULES OF ENGAGEMENT (U)

HEADQUARTERS
COMMANDER IN CHIEF, US PACIFIC COMMAND
CAMP H. M. SMITH, HI 96861
11 June 1984

SECRET

USCINCPAC RECOVERY PLAN

(b) (U) USCINCPAC will issue supplemental ROE as required upon execution of this plan.

(c) (U) All possible actions shall be taken, including the use of deadly force, to preclude unauthorized access to or seizure or theft of a nuclear weapon.

(2) (U) General ROE Policy

(b) (S) Responses to hostile fire or other hostile acts directly threatening US lives and property will be directed to the source of the hostile fire or act and will be conducted with speed and restraint to prevent escalation. Pursuit, as necessary, to drive off the attacker and to determine that the present hostile intent has been abandoned is authorized.

UNCLASSIFIED
UNCLASSIFIED

USCINCPAC RECOVERY PLAN

b. (U) Tasks. These ROE provide general guidelines for component/subordinate commanders and commanders of recovery forces in support of this plan. Specific ROE promulgated by subordinate commanders will be forwarded to USCINCPAC for approval.

c. (U) Coordinating Instructions

(1) (U) US forces will adhere to approved ROE. Should host nation ROE be more restrictive, they will be adhered to when feasible.

(2) (U) The Commander, MRF (when activated), will provide approved ROE to assigned forces.

4. (U) ADMINISTRATION. Violations of ROE will be reported to USCINCPAC, the JCS and other commanders as appropriate.

5. (U) COMMAND AND SIGNAL

a. (U) Command. See basic plan.

b. (U) Signal. Annex K.

UNCLASSIFIED
UNCLASSIFIED

UNCLASSIFIED

USCINCPAC RECOVERY PLAN

(THIS PAGE INTENTIONALLY LEFT BLANK)

C-8-4

UNCLASSIFIED

UNCLASSIFIED
UNCLASSIFIED

HEADQUARTERS

COMMANDER IN CHIEF, US PACIFIC COMMAND

CAMP H. M. SMITH, HI 96861

11 June 1984

ANNEX F TO USCINCPAC RECOVERY PLAN
PUBLIC AFFAIRS

- REFERENCES: (a) DOD Directive 5230.16 of 7 February 1983
(b) CINCPACINST S8110.4B of 14 August 1979
(c) CINCPACINST 5720.4D of 5 September 1978

1. SITUATION

a. General. The conduct of Public Affairs (PA) during all phases of the effort to locate and recover a lost, seized, or stolen nuclear weapon will be critical to the success of the operation. Designated public affairs personnel from all federal agencies concerned and from foreign countries involved, if any, will participate as active members of the planning team and will prepare appropriate statements and responses to queries as necessary. During the initial stages, it may be necessary to react to queries from the news media in a positive manner while observing the requirements to maintain the "neither confirm nor deny" policy. If a decision is made to confirm the presence of a weapon in the interest of public safety or to preclude wide spread public alarm, the procedures outlined in references (a) and (b) will be used as modified to fit the situation. However, all information will be cleared by USCINCPAC PAO prior to release. Additionally, PA operations will require careful coordination between all participating Federal agencies at the field, national, and international levels where appropriate.

b. Enemy. Enemy forces cannot be predetermined and will depend upon the exact nature and location of the incident. However, in general terms, they may be generally identified as the group in possession of the nuclear weapon, other affiliated terrorist organizations, dissident groups throughout the world, and those international organizations that have indicated a desire to possess a nuclear weapon for whatever reason.

c. Friendly. Situation and location dependent.

d. Assumptions

(1) Adequate communications will be available to provide real-time, accurate exchange of information between the operation area and the national level.

(2) State, local, and host nation authorities will be represented by properly accredited personnel at the operation area.

(3) Secure communications will be available between coordinating agencies.

UNCLASSIFIED

UNCLASSIFIED

(4) Public Affairs personnel familiar with public affairs policy for nuclear accidents/incidents will have to be moved to the location of the situation.

2. MISSION. The mission of the PA elements in a situation of this nature is to insure that US government representatives speak with one voice, provide accurate and timely information to the media, and are consistent with national security considerations.

3. EXECUTION

a. Concept of Operations. All PA activities will be under the specific direction of the ASD(PA) in close coordination with the Public Affairs Office (J03/74) of USCINCPAC.

b. Media Center. A media center will be established in proximity to the operations area under direction of the On-Scene Commander.

c. Public Affairs Personnel. Public affairs responsibility will be assumed by the Public Affairs Officer for the On-Scene Commander. USCINCPAC Public Affairs will deploy members of the USCINCPAC Mobile Public Affairs Team (MPAT) as may be needed as outlined in reference (c). In addition, Public Affairs offices and Audio/Visual facilities in the area in which the situation occurs may be tasked as needed to provide additional personnel.

d. Media Center Operations. The media center will have responsibility for making any news releases from the scene; accrediting all news media afforded access to the scene; coordinating all proposed statements/responses/releases with appropriate higher authority; and keeping higher authority informed about public affairs coverage at the scene.

e. Media Access. Access will be denied if required for reasons of safety and to avoid providing a forum to the terrorists. Under no circumstances will Government agencies facilitate access to the media by the perpetrators of a nuclear weapon theft.

f. Coordinating Instruction. PA policy and plans will be coordinated with ASD(PA), Joint Chiefs of Staff, applicable host nations, and other US agencies by USCINCPAC.

4. ACCREDITATION. On-Scene Commander will coordinate media accreditation as required for unilateral operation. The host nation will be consulted, through the US Embassy, as required, for other recovery operations.

5. FIELD PRESS WARTIME INFORMATION SECURITY PROGRAM (WISP): A decision may be made by USCINCPAC or higher authority to invoke WISP. In any event, the On-Scene Commander and his Public Affairs Officer will exercise strict control over both media access to the scene and the release of information to the media.

UNCLASSIFIED

UNCLASSIFIED

USCINCPAC RECOVERY PLAN

6. SECURITY. All information will be cleared by USCINCPAC prior to its release to the media. There will be no release of detailed information on operations, location of search areas, or status of terrorists actions or hostage situations that might provide the enemy key information upon which to make subsequent plans and actions.

7. AUDIOVISUAL. USCINCPAC PAO will task component closest to the situation to provide film/video tape coverage of ongoing search or recovery operations as required. Requests for approval of news media coverage of search and recovery operations will be forwarded to USCINCPAC PAO for coordination with OASD(PA). On-scene filming and video/audio recording by the news media will not be authorized. Audiovisual material providing scenes of ongoing operations will not be released.

WILLIAM J. CROWE, JR.
Admiral
Commander in Chief

OFFICIAL:

Marvin L. Braman
MARVIN L. BRAMAN
Colonel
Public Affairs Officer

UNCLASSIFIED

UNCLASSIFIED
UNCLASSIFIED

USCINCPAC RECOVERY PLAN

(THIS PAGE INTENTIONALLY LEFT BLANK)

UNCLASSIFIED

~~SECRET~~
HEADQUARTERS
COMMANDER IN CHIEF, US PACIFIC COMMAND
CAMP H. M. SMITH, HI 96861
11 June 1984

ANNEX J TO USCINCPAC RECOVERY PLAN (U)
COMMAND RELATIONSHIPS (U)

1. (U) GENERAL

a. (U) Purpose. This annex establishes relationships between USCINCPAC and:

- (1) (U) NCA
- (2) (U) JCS
- (3) (U) DOS
- (4) (U) DOJ/FBI
- (5) (U) USCINCPAC component/subordinate unified commanders
- (6) (U) American embassies, governments and host nation armed forces.

b. (U) Scope. These command relationships apply to recovery operations conducted in support of this plan.

2. (U) COMMAND LINES

a. (U) Service Components. Operational control of facility, installation or ship from which nuclear weapon was lost, seized or stolen and site security forces involved in hot pursuit operations.

CLASSIFIED BY: DEPUTY CHIEF OF STAFF
DECLASSIFY ON: OADR

J-1

~~SECRET~~
(This page is UNCLASSIFIED)

USCINCPAC RECOVERY PLAN

(1) (U) Operations in Hawaii, the Aleutians and the TTPI.

(a) (U) Responsibility for search and recovery will be transferred from USCINCPAC to the FBI as soon as possible. USCINCPAC will continue to support search and recovery operations as required on a priority basis.

(c) (U) If the weapon is taken from Hawaii, the Aleutians or the TTPI into international waters or foreign countries, the operation is then treated as OCONUS and responsibility will be transferred to DOS as soon as possible.

(2) (U) OCONUS Operations. The US Ambassador, as the senior US government representative to the host nation in which recovery operations are to be conducted, has overall responsibility for coordinating US search and recovery operations. The Commander, JTF/MRF will be responsible for planning, coordinating, and executing the assault operations. If possible, timing and location of assault operations will be approved by the US Ambassador to the nation in which the recovery operation will be conducted.

c. (U) Commander, Special Operations Command US Pacific Command (COMSOPAC) may be tasked to support this plan.

3. (U) SUPPORT AND COORDINATION RELATIONSHIPS

b. (U) USCINCPAC will coordinate interservice support required between/by service component commanders. COMUSKOREA and COMUSJAPAN will coordinate interservice support required within their respective AOR by subordinate service component commanders.

UNCLASSIFIED

USCINCPAC RECOVERY PLAN

4. (U) RELATIONSHIPS WITH INTERNATIONAL AND FOREIGN COMMANDS AND ORGANIZATIONS

a. (U) US forces will remain under US command at all times.

b. (U) Direct coordination between MRF/JTF and host nation recovery forces is authorized to facilitate search and recovery operations.

5. (U) PLANNING RELATIONSHIPS

a. (U) CINCPACAF is responsible for contingency planning involving operations under this plan to recover nuclear weapon(s) which have been lost, seized or stolen from AIR FORCE custody.

b. (U) CINCPACFLT is responsible for contingency planning involving operations under this plan to recover nuclear weapon(s) which have been lost, seized or stolen from PACFLT custody.

c. (U) CDRWESTCOM will provide available Army forces in support of operations under this plan.

d. (U) Direct coordination is authorized with local and state officials to facilitate hot pursuit operations in CONUS as defined in the plan; for OCONUS operations all coordination with host nation officials will be effected by American Embassies or Consulates.

WILLIAM J. CROWE, JR.
Admiral
Commander in Chief

Appendices:

- 1 - Command Relationships - Hawaii/Aleutians
- 2 - Command Relationships - Foreign Countries (except Japan and Korea)
- 3 - Command Relationships - Japan and Korea
- 4 - Command Relationships - Trust Territories of the Pacific Islands

OFFICIAL:

R. E. KIRKSEY
Rear Admiral
Director for Plans and Policy

J-3

UNCLASSIFIED

UNCLASSIFIED

USCINCPAC RECOVERY PLAN

(THIS PAGE INTENTIONALLY LEFT BLANK)

UNCLASSIFIED

~~CONFIDENTIAL~~

~~CONFIDENTIAL~~
~~CONFIDENTIAL~~

(THIS PAGE INTENTIONALLY LEFT BLANK)

J-1-2

~~CONFIDENTIAL~~
~~CONFIDENTIAL~~
FORMERLY RESTRICTED DATA

(This page is UNCLASSIFIED)

UNCLASSIFIED
UNCLASSIFIED

HEADQUARTERS

COMMANDER IN CHIEF, US PACIFIC COMMAND
CAMP H. M. SMITH, HI 96861

11 June 1984

APPENDIX 2 TO ANNEX J TO USCINCPAC RECOVERY PLAN (U)
COMMAND RELATIONSHIPS - FOREIGN COUNTRIES (EXCEPT JAPAN AND KOREA)

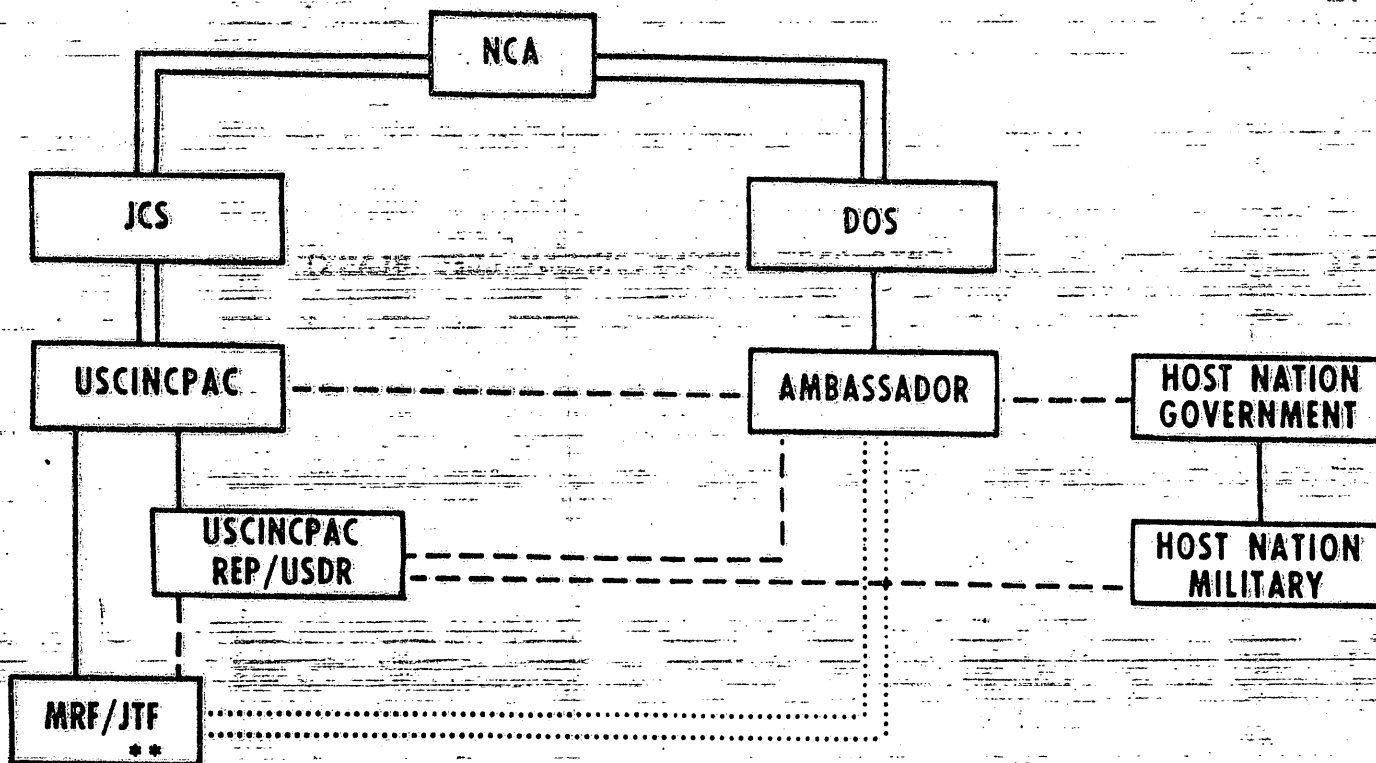

** JTF IF DESIGNATED

== DIRECTION

— OPCOM/OPCON

- - - COORDINATION

..... SUPPORT

J-2-1

UNCLASSIFIED

UNCLASSIFIED

USCINCPAC RECOVERY PLAN

(THIS PAGE INTENTIONALLY LEFT BLANK)

J-2-2

UNCLASSIFIED

UNCLASSIFIED
UNCLASSIFIED

HEADQUARTERS
COMMANDER IN CHIEF, US PACIFIC COMMAND
CAMP H. M. SMITH, HI 96861
11 June 1984

APPENDIX 3 TO ANNEX J TO USCINCPAC RECOVERY PLAN (U)
COMMAND RELATIONSHIPS - JAPAN AND KOREA

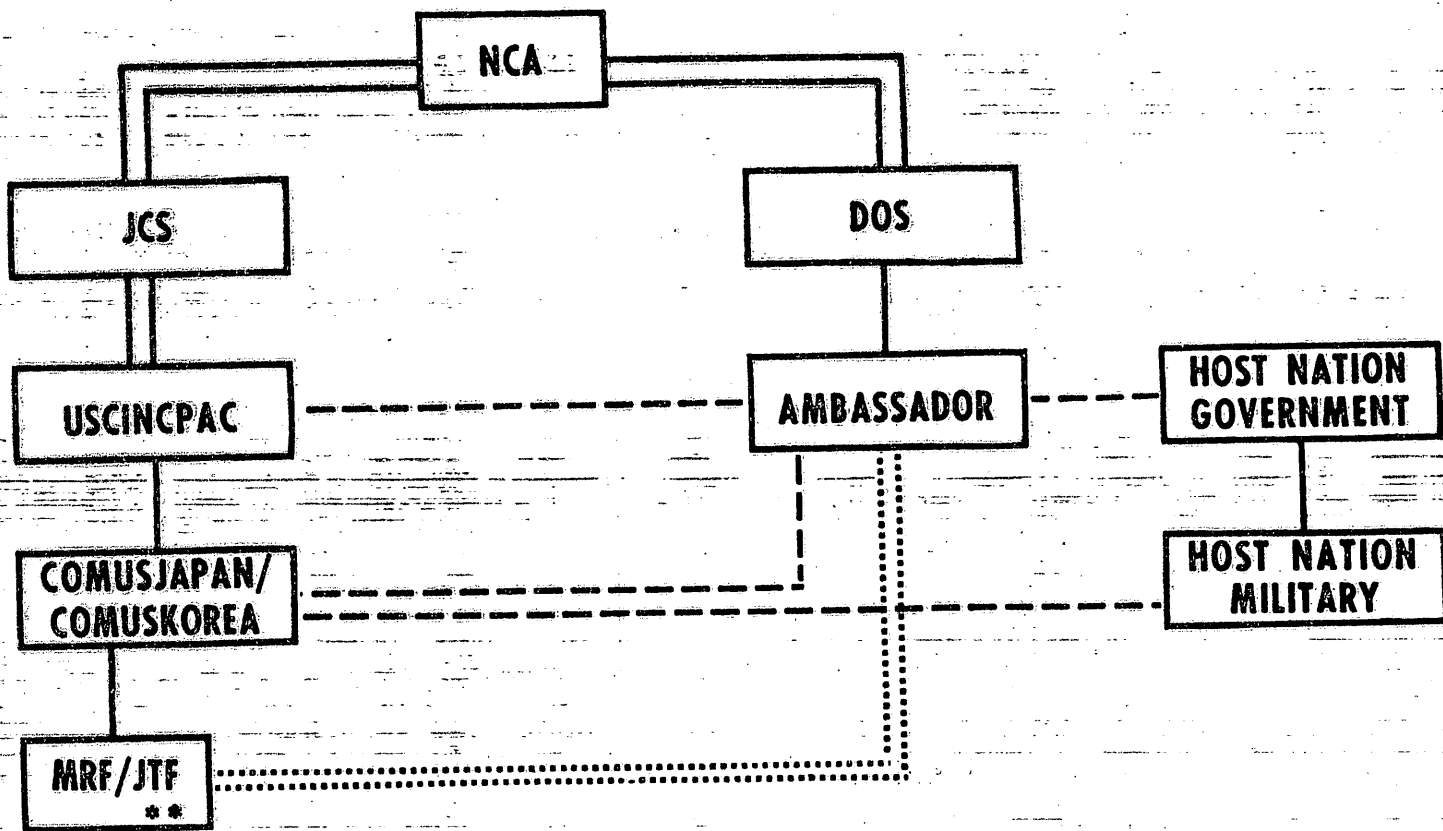

- ** IF DESIGNATED
- ==== DIRECTION
- OPCOM/OPCON
- - - COORDINATION
- SUPPORT

UNCLASSIFIED

UNCLASSIFIED
UNCLASSIFIED

HEADQUARTERS
COMMANDER IN CHIEF, US PACIFIC COMMAND
CAMP H. M. SMITH, HI 96861
11 June 1984

APPENDIX 4 TO ANNEX J TO USCINCPAC RECOVERY PLAN (U)
COMMAND RELATIONSHIPS - TRUST TERRITORIES OF THE PACIFIC ISLANDS

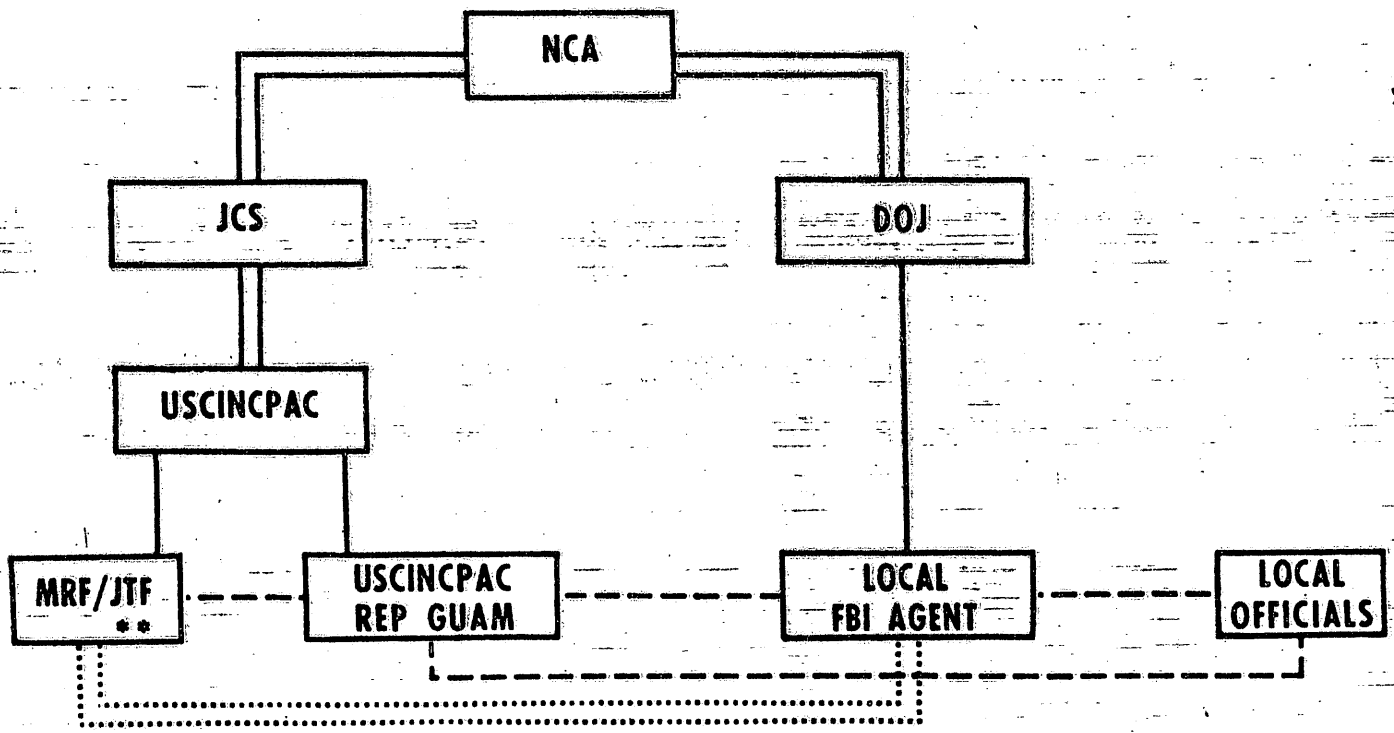

- ** IF DESIGNATED
- == DIRECTION
- OPCOM/OPCON
- - - COORDINATION
- SUPPORT

UNCLASSIFIED

USCINCPAC RECOVERY PLAN

(THIS PAGE INTENTIONALLY LEFT BLANK)

UNCLASSIFIED

~~SECRET~~

HEADQUARTERS
COMMANDER IN CHIEF, US PACIFIC COMMAND
CAMP H. M. SMITH, HI 96861
11 June 1984

ANNEX K TO USCINCPAC RECOVERY PLAN (U)
COMMUNICATIONS-ELECTRONICS (U)

- (U) REFERENCES:
- (a) JCS MOP 167, Mobile/Transportable Communications Assets
 - (b) JCS PUB 6, Joint Reporting Structure, Volume II, Part 2, Chapter 1, 1 April 1980, Unit Status and Identity Report (UNITREP)
 - (c) USCINCPACINST 2011.1B, 23 Apr 84, Joint Crisis Management Capability Level 1 (JCMC 1)
 - (d) JCS MOP 112, Military Telecommunications Agreements Between the United States and Regional Defense Organizations of Friendly Foreign Nations
 - (e) DCA Review of Area Communications-Electronics Capabilities, Volumes I through IV
 - (f) JCS PUB 2, Unified Action Armed Forces (UNAAF)
 - (g) JCS PUB 3, Joint Logistics and Personnel Policy and Guidance
 - (h) CINCPACINST C2000.1C, Pacific Command, Communications-Electronics Instructions (PACOM CEI)
 - (i) DCS Circuit Directory
 - (j) DCA-PAC Systems Brochure
 - (k) USREDCOM Manual 105-1, Joint Communications Support Element (JCSE)
 - (l) CINCPACINST 2400.1D, Electromagnetic Spectrum Management Policy
 - (m) CINCPACINST S3320.3B, Procedures for the Use of Identification or Foe (IFF) Mark X Selective Identification Feature (SIF)/Mark XII in the Pacific Command.
 - (n) HQ PACAF Plan, Security Control of Air Traffic and Air Navigation Aids (SCATANA), 15 January 1972

1. (U) GENERAL

a. (U) Purpose. This Annex provides the direction and coordinating instructions for provisions of communications-electronics (C-E) support specifically designed for rapid response to requirements to communicate between the National Military Command Center (NMCC), USCINCPAC and the Commander of the Military Recovery Force (COMMRF) during operations conducted under this plan.

CLASSIFIED BY: DEPUTY CHIEF OF STAFF
DECLASSIFY ON: OADR

K-1

~~SECRET~~
(This page is UNCLASSIFIED)

USCINCPAC RECOVERY PLAN

b. (U) Situation

(1) (U) General

(a) (U) See basic plan.

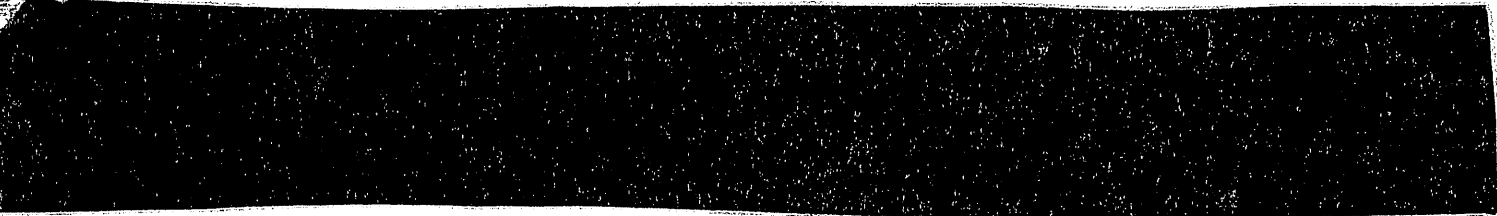

(2) (U) Enemy

(a) (U) See Annex B.



(3) (U) Friendly. All communications systems and facilities available to the UNITED STATES will be considered for use in support of this plan.

(a) (U) The following C-E capabilities are considered available for appropriate tasking in supporting plans:

1. (U) C-E forces and capabilities of the military services and unified and specified commands.

2. (U) Defense Communications System (DCS) to include AUTODIN, OVON, and AUTOSEVOCOM and transmission systems including Defense Satellite Communications System (DSCS).

3. (U) Mobile/transportable communications assets controlled by the Joint Chiefs of Staff as listed in references (a) and (b) and two USCINCPAC lightweight satellite terminals and four USCINCPAC PARKHILL (KY-65) devices (reference (c)).

4. (U) Airborne command and control and radio relay assets listed in reference (d).

5. (U) Commercial telecommunications capabilities.



7. (U) Naval vessels with long haul (satellite and HF) communications capabilities.

8. (U) Diplomatic Telecommunications Service (DTS). See Appendix 3.

9. (U) Specialized DOD facilities and networks, such as MYSTIC STAR, Improved Emergency Message Automatic Transmission System (IEMATS), and Special Intelligence Communications (SPINTCOMM).

10. (U) Facilities and networks of the National Communications System (NCS).

(b) (U) Summaries of worldwide C-E capabilities which may be considered in supporting plans are contained in reference (e).

2. (U) MISSION. Provide secure, responsive, and reliable command and control communications between the NMCC, USCINCPAC and the assigned tactical commanders.

3. (U) EXECUTION

a. (U) Guiding Principles

(1) (U) Communications supporting plans will be in accordance with this Annex.

(3) (U) Communications systems designed specifically to support this plan will provide for maximum flexibility to support a wide range of scenarios in an equally wide range of geographical locations.

(c) (U) As a minimum, at least one high quality secure voice circuit, and one 100-WPM (75 baud) secure teletype circuit, will be provided between the NMCC, USCINCPAC and COMMRP and other USPACOM units as required.

(d) (U) Tactical communications between USCINCPAC, COMMRP and assigned forces will utilize existing communications packages in airborne/ground/afloat platforms as required. Detailed planning for circuitry between COMMRP and subordinate elements cannot be completed until the size, type, and disposition of forces assigned is determined, and the location and characteristics of the objective area become known. Detailed planning considerations will be addressed in execution planning guidance.

(4) (U) Communications discipline at all levels of command is required for mission success. C-E personnel and C-E systems users will be thoroughly trained and indoctrinated on the COMSEC aspects of this plan. See Appendix 1.

(5) (U) References (f) and (g) provide policy/guidance for communications support for unified and joint operations.

(6) (U) Current Joint Army-Navy-Air Force Publications (JANAP) and Allied Communication Publications (ACP) apply.

(7) (U) Direct communications with diplomatic posts will be established when authorized by USCINCPAC. Secure record communications via AUTODIN will use routing indicators listed in ACP-117 and Plan Language Addresses (PLA's) from NTP 3, Supplement 1.

(8) (U) Contingency assets will be requested by USCINCPAC and subordinate commanders, as required. Whenever theater augmentation is required, USCINCPAC will act as the single point of contact with other unified and specified commanders and the JCS. Use of contingency assets are subject to references (a) and (h) and this plan.

(9) (U) USCINCPAC crisis communications are in Appendix 5.

b. (U) Operational Concept

(1) (U) Upon receipt of initial JCS planning guidance, secure voice and record communications nets will be activated. Upon deployment, secure communications will be maintained. Necessary circuitry will be established for secure voice and record communications.

(a) (U) Existing capabilities will be used to the maximum extent possible to meet these requirements.

(b) (U) Commercial circuitry secured with appropriate transportable COMSEC equipment will be used when existing Government-owned facilities are not sufficient or available.

(c) (U) C-E assets will be deployed as necessary to support communications within areas of operations.

(2) (U) Airborne command and control platforms, such as JACC/CP, AWACS, ABCCC, or ABNCP, may be used.

(a) (U) The airborne platform must provide at least one high quality secure voice circuit and one 100-WPM (75 baud) secure teletype circuit.

(b) (U) When suitable existing ground entry points are not available for the airborne platform(s), mobile/transportable assets and/or naval vessels will be used.

(3) (U) When tasked by JCS to prepare to execute this plan, communications will be established with COMMRP in the marshaling area as shown in Tab A to Appendix 4.

(4) (U) While in the Marshaling area/Intermediate Staging Area (ISA)/rehearsal area, communications will be established as shown in Tabs A and B to Appendix 4.

(5) (U) Communications in the objective area will be as shown in Tab C to Appendix 4.

(6) (U) During execution planning, USCINCPAC will:

(a) (U) Initiate requests for secure voice and record circuits to the marshaling area and ISA/rehearsal area.

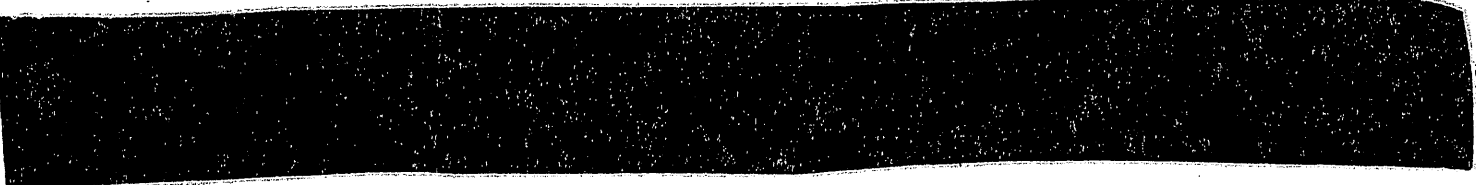

(c) (U) Provide for electromagnetic spectrum management support to COMMRP.

(d) (U) Arrange for Prime Mover to support the JCACC/CP on the ground, if required.



c. (U) Tasks and Responsibilities

(1) (U) CINCPACFLT will prepared to:

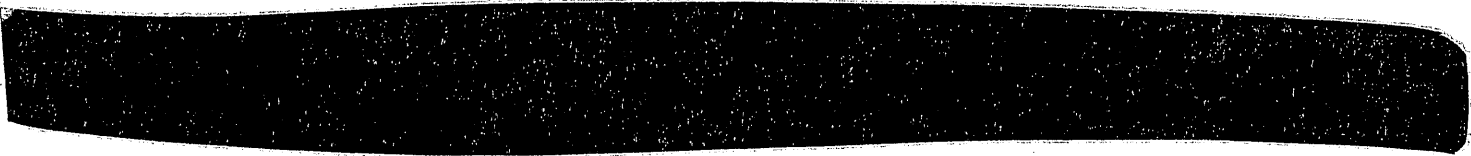

[REDACTED]

COMMRF. (c) (U) Provide electromagnetic spectrum management support for

(2) (U) CINCPACAF will be prepared to:

[REDACTED]

COMMRF. (b) (U) Provide electromagnetic spectrum management support for

[REDACTED]

(3) (U) CDRWESTCOM will be prepared to:

[REDACTED]

(b) (U) Provide frequency spectrum management support for COMMRF.

[REDACTED]

(5) (U) USCINCRD will be prepared to:

[REDACTED]

(b) (U) Provide personnel to augment the electromagnetic spectrum management for COMJTF.

[REDACTED]

(6) (U) COMMRF will:

(a) (U) Establish continuous secure voice and record communications with higher commanders.

~~UNCLASSIFIED~~
UNCLASSIFIED

USCINCPAC RECOVERY PLAN

(b) (U) Use radio as primary means of communications with component commanders while in the objective area.

(c) (U) Install wire communications only if time permits.

(d) (U) Make maximum use of secure communications due to sensitive nature of this mission.

d. (U) Coordinating Instructions

(1) (U) C-E procedures not specifically covered in this plan will be managed in accordance with reference (h).

(2) (U) References (i) and (j) describe the DCS in the Pacific area.

(3) (U) Typical Joint Task Force communications are shown in reference (k).

(4) (U) Capabilities of the JACC/CP are in reference (l).

4. (U) SPECIAL MEASURES

a. (U) The senior C-E officer assigned to the MRF will have authority to coordinate directly with the Command Control and Communications Systems (C3S) Directorate, OJCS and other services on the C-E aspects of this plan while ensuring USCINCPAC is kept informed.

b. (U) Frequency planning and coordination will be in accordance with references (h) and (l).

c. (U) Identification, friend or foe/selective identification feature (IFF/SIF) procedures will be in accordance with reference (m).

d. (U) Security control of air traffic and air navigation aids (SCATANA) will be in accordance with CINCPACAF and supporting SCATANA plans (see reference (n)).

5. (U) LOGISTICS

a. (U) See paragraph 4 to basic plan and Annex D.

b. (U) Services tasked to provide C-E support for this plan will provide or arrange for all associated logistics support.

c. (U) Airlift priority will be established by the Joint Chiefs of Staff for C-E deployments directed in support of this plan.

UNCLASSIFIED

UNCLASSIFIED
UNCLASSIFIED

USCINCPAC RECOVERY PLAN

6. (U) ADMINISTRATION

a. (U) Communications logs will be maintained for all C-E activities associated with this plan.

b. (U) Appropriate C-E reports IAW reference (b) will be submitted.

WILLIAM J. CROWE, JR.
Admiral
Commander in Chief

Appendices:

- 1 - Communications Security
- 3 - Diplomatic Telecommunications Service Secure Record Communications
- 4 - MRF Communications Requirements
- 5 - USCINCPAC Crisis Situation Command and Control Communications

OFFICIAL:

V.O. Lang
V. O. LANG
Major General
Director, C3S

K-8

UNCLASSIFIED
UNCLASSIFIED

~~SECRET~~
HEADQUARTERS
COMMANDER IN CHIEF, US PACIFIC COMMAND
CAMP H. M. SMITH, HI 96861
11 June 1984

APPENDIX 1 TO ANNEX K TO USCINCPAC RECOVERY PLAN (U)
COMMUNICATIONS SECURITY (U)

(U) REFERENCE: (a) JCS MOP 131 (4th Revision), 2 May 1975, Joint and Combined Communications Security Policy

1. (U) PURPOSE. To provide COMSEC guidance necessary to enhance the operational security of forces tasked. The C-E operational environment and the required COMSEC support will depend upon the nature of the situation. Detailed COMSEC measures for C-E plans will be developed as an actual situation becomes known and will comply with the guidelines provided in reference (a).

2. (U) GENERAL

a. (U) An opposing force can degrade communications effectiveness by:

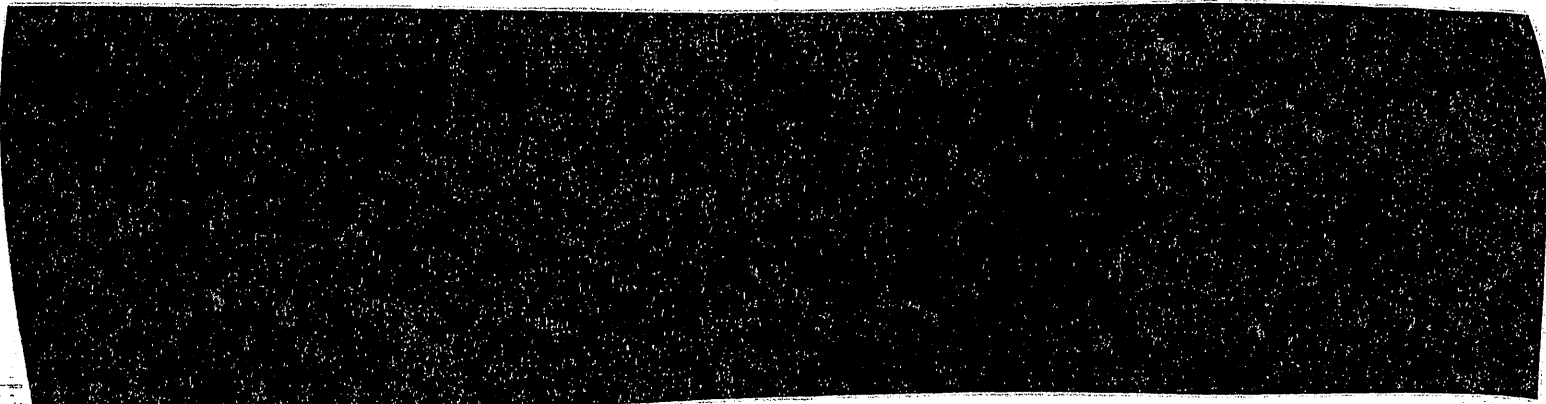
b. (U) All available COMSEC must be used to protect communications from exploitation and maintain operational security.

3. (U) EXECUTION

CLASSIFIED BY: DEPUTY CHIEF OF STAFF
DECLASSIFY ON: OADR

~~SECRET~~

a. (U) Concept for COMSEC Support Operations

(1) (U) Commanders will insure that only secure equipment/materials (OPCODEs) are used for the transmission of classified/sensitive communications.

[REDACTED]

(3) (U) Communications will be encrypted to the maximum extent possible while still permitting mission accomplishment. On-line systems will be used when possible, and if such systems are not available, appropriate off-line systems and operations codes will be used.

[REDACTED]

(5) (U) Predeployment coordination of times, routes, frequencies, and call signs will be accomplished by secure communications.

(7) (U) As required, deceptive C-E asset deployments, and communications difficulties, including equipment/system malfunctions/limitations/or procedure problems, will not be discussed in the clear.

[REDACTED]

(9) (U) COMSEC Surveillance Reporting. In order to insure that the Commander, MFR, is continually apprised of the SIGSEC status of the operations, the COMSEC monitor team will produce the following reports:

(a) (U) Spot Reports. When information of possible intelligence significance is revealed, a spot report should be immediately sent to the Task Force Commander so that he can take appropriate action to counter the possible damage done. This report will be short and concise and usually will be transmitted to the consumer via secure means.

(b) (U) Daily Summaries (DASUMs). DASUMs of possible intelligence significance, which do not meet spot report criteria, will be reported in letter format to the COMMRF through the senior intelligence representative. The report will contain the following three sections: a summary of spot reports issued; a summary of information monitored, including analyst comments, keyed to an Essential Elements of Friendly Information (EEFI) list; and a summary of information monitored, including analyst comments, which, although it does not specify EEFI list criteria, is still of possible intelligence value.

~~SECRET~~

(c) (U) After-Action Report. Within 10 days after the termination of monitoring, the support SIGSEC agency(ies) will forward, in letter format to the participating entities, a comprehensive report detailing the force's SIGSEC posture during the operation. This report will not be limited to a particular format but will provide a detailed discussion of each finding presented and contain recommendations for improving the SIGSEC posture of future operations.

b. (U) Tasks

(1) (U) USCINCPAC will:

(a) (U) Prepare a COMSEC support plan in coordination with the Director, NSA.

(b) (U) Determine Joint COMSEC material requirements, when directed.

(2) (U) CDRWESTCOM, CINCPACFLT, and CINCPACAF will prepare COMSEC support plans, when directed.

~~CONFIDENTIAL~~

c. (U) Coordinating Instructions. To be developed in supporting plans.

4. (U) COMMAND AND SIGNAL

a. (U) Maximum use will be made of existing COMSEC systems.

b. (U) COMSEC violations, instances of interference, or jamming will be reported by secure means only.

5. (U) ADMINISTRATION AND LOGISTICS. In accordance with the Basic Plan.

Tab:

- A - USPACOM Contingency/Exercise Codes/Keylists
- B - USPACOM Code Systems
- C - USPACOM Changing Call Signs and Frequency Systems
- D - USPACOM Authentication Systems

~~CONFIDENTIAL~~

USCINCPAC RECOVERY PLAN

(THIS PAGE INTENTIONALLY LEFT BLANK)

K-1-4

~~CONFIDENTIAL~~

(This page is UNCLASSIFIED)

~~CONFIDENTIAL~~
HEADQUARTERS
COMMANDER IN CHIEF, US PACIFIC COMMAND
CAMP H. M. SMITH, HI 96861
11 June 1984

TAB A TO APPENDIX 1 TO ANNEX K TO USCINCPAC RECOVERY PLAN (U)
USPACOM CONTINGENCY/EXERCISE CODES/KEYLISTS (U)

1. (U) GENERAL. A complete listing of codes and keylists for use in combined operations is contained in NSA Publication CCG-1.
2. (U) USPACOM KEYLISTS

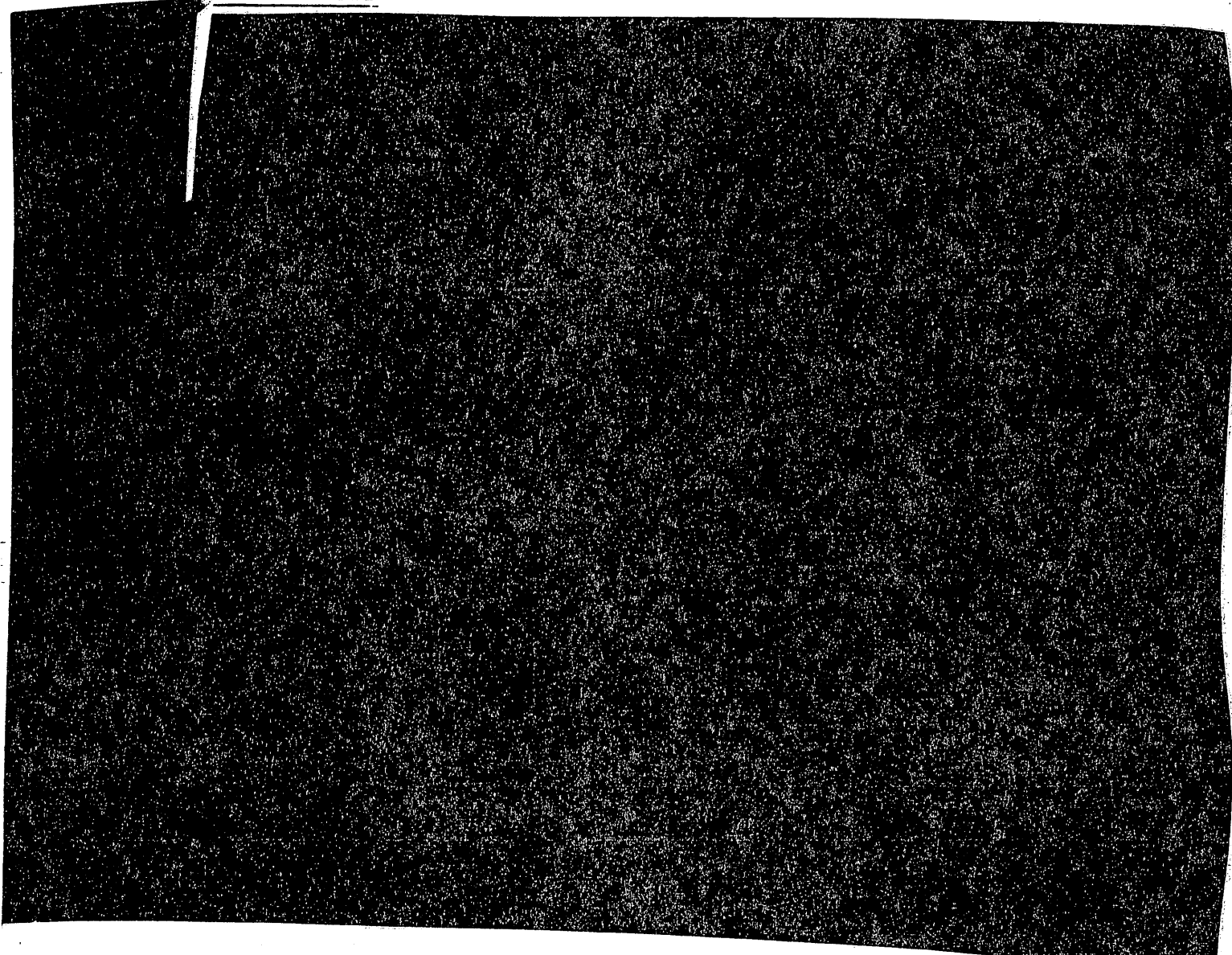

CLASSIFIED BY: DEPUTY CHIEF OF STAFF
DECLASSIFY ON: OADR

K-1-A-1

~~CONFIDENTIAL~~
~~CONFIDENTIAL~~

~~CONFIDENTIAL~~

USCINCPAC RECOVERY PLAN

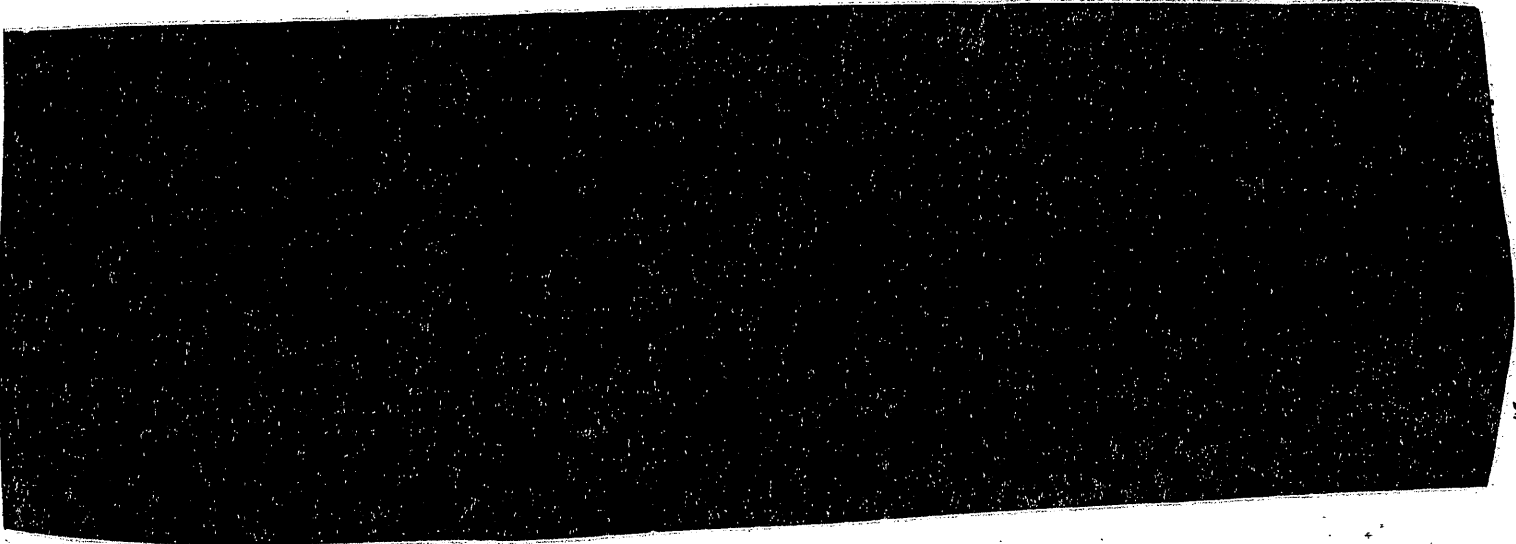

~~CONFIDENTIAL~~

~~CONFIDENTIAL~~

HEADQUARTERS
COMMANDER IN CHIEF, US PACIFIC COMMAND
CAMP H. M. SMITH, HI 96861
11 June 1934

TAB B TO APPENDIX 1 TO ANNEX K TO USCINCPAC RECOVERY PLAN (U)
USPACOM CODE SYSTEMS (U)

1. (U) GENERAL. A complete listing of codes and keylists for use in combined operations is contained in NSA Publication CCG-1.

2. (U) USPACOM CODE SYSTEMS

a. (U) ACP 165 Operational Brevity Codes. (Allied Restricted) ACP 165 contains a compilation of operational brevity codes for use in radio telephone communications. Brevity codes provide no communications security unless used in conjunction with an authorized US COMSEC operations code.

CLASSIFIED BY: DEPUTY CHIEF OF STAFF
DECLASSIFY ON: OADR

K-1-B-1

USCINCPAC RECOVERY PLAN

~~CONFIDENTIAL~~
~~CONFIDENTIAL~~

(THIS PAGE INTENTIONALLY LEFT BLANK)

K-1-B-2

~~CONFIDENTIAL~~

~~CONFIDENTIAL~~

HEADQUARTERS
COMMANDER IN CHIEF, US PACIFIC COMMAND
CAMP H. M. SMITH, HI 96861
11 June 1984

TAB C TO APPENDIX 1 TO ANNEX K TO USCINCPAC RECOVERY PLAN (U)
USPACOM CHANGING CALL SIGN AND FREQUENCY SYSTEMS (U)

1. (U) GENERAL. All services are responsible for providing call signs to support USCINCPAC sponsored operations from the current edition of their respective call sign publication.

2. (U) SYSTEMS

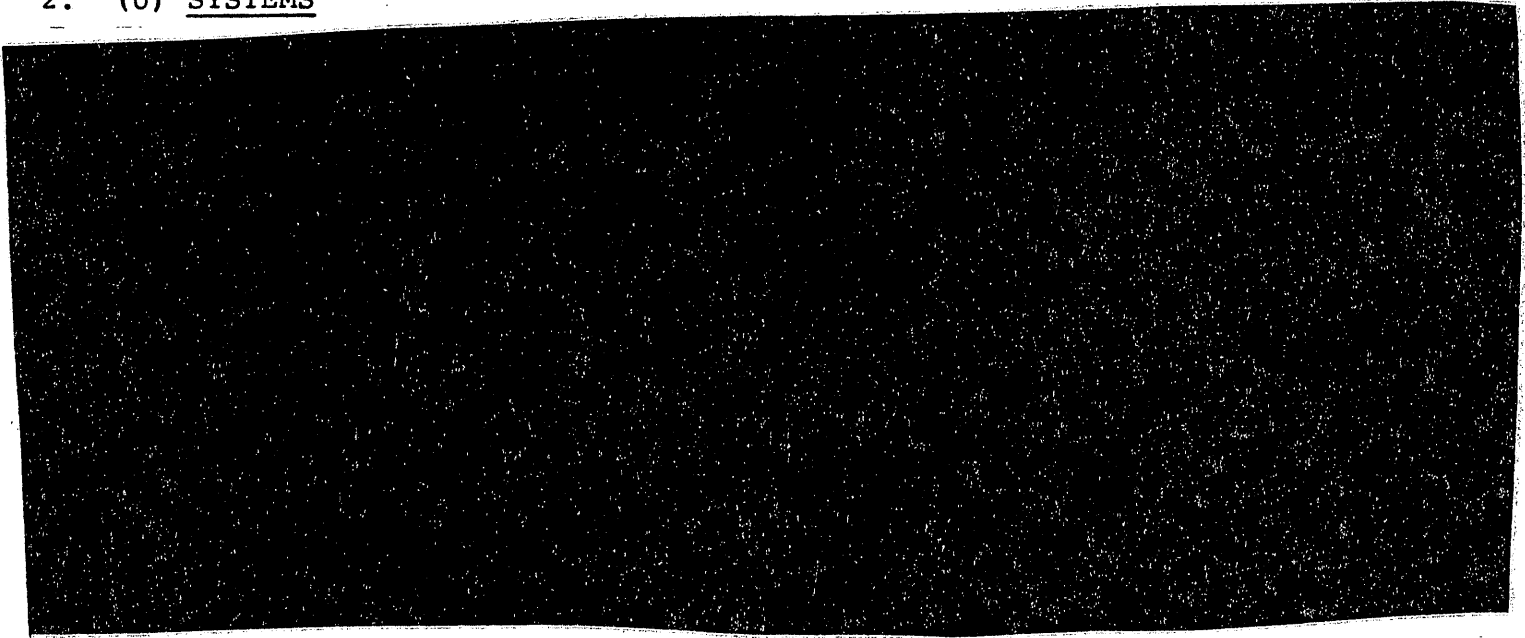

CLASSIFIED BY: DEPUTY CHIEF OF STAFF
DECLASSIFY ON: OADR

K-1-C-1

~~CONFIDENTIAL~~

~~CONFIDENTIAL~~

USCINCPAC RECOVERY PLAN

(THIS PAGE INTENTIONALLY LEFT BLANK)

K-1-C-2

~~CONFIDENTIAL~~

(This page is UNCLASSIFIED)

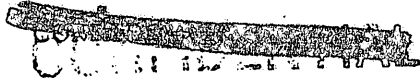

HEADQUARTERS
COMMANDER IN CHIEF, US PACIFIC COMMAND
CAMP H. M. SMITH, HI 96861
11 June 1994

TAB D TO APPENDIX 1 TO ANNEX K TO USCINCPAC RECOVERY PLAN (U)
USPACOM AUTHENTICATION SYSTEMS (U)

1. (U) GENERAL. General guidelines for authentication are contained in ACP 122. Authentication is mandatory under the conditions promulgated in Article 417, ACP 122.

2. (U) USPACOM AUTHENTICATION SYSTEMS

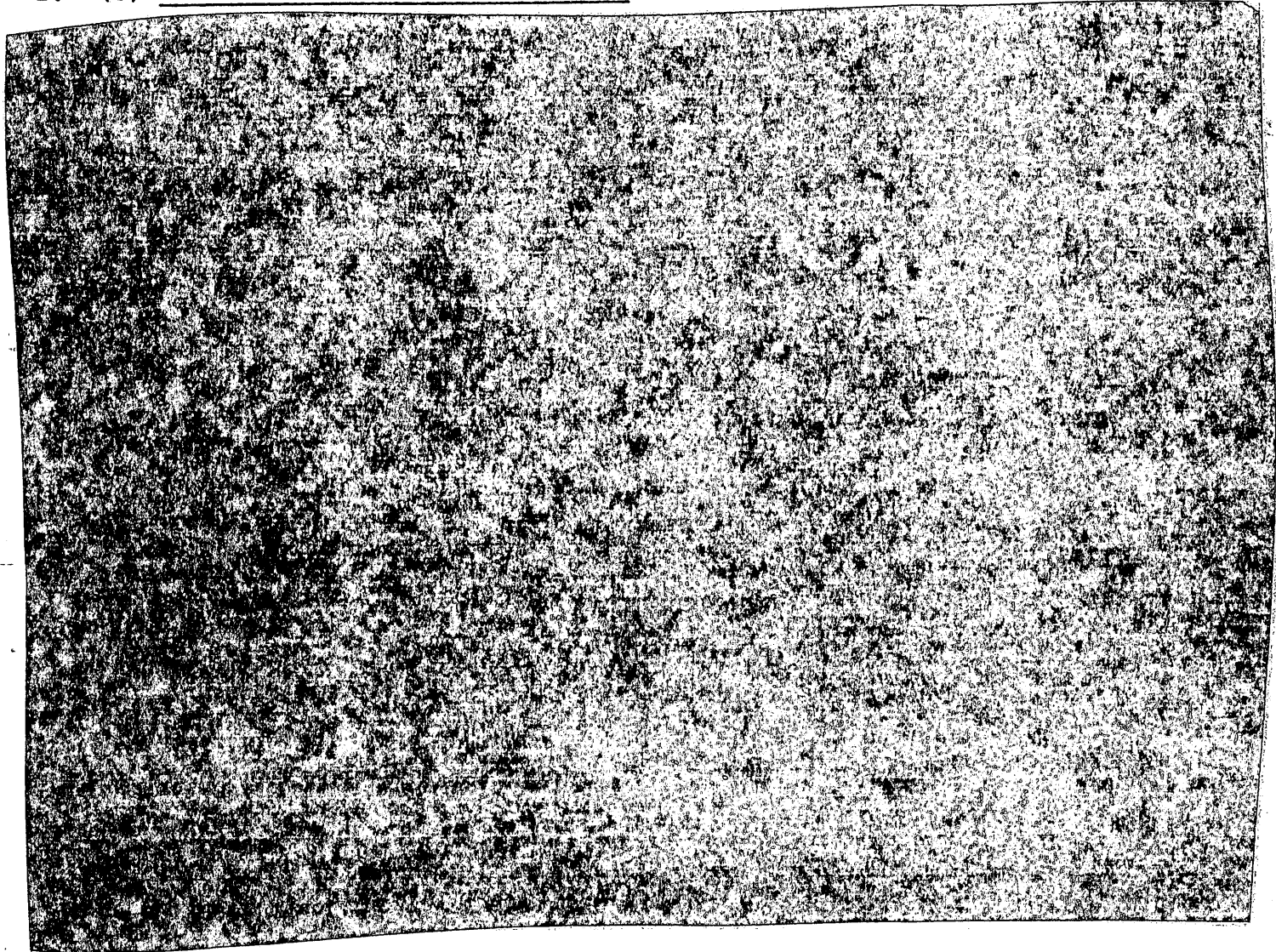

CLASSIFIED BY: DEPUTY CHIEF OF STAFF
DECLASSIFY ON: OADR

K-1-D-1

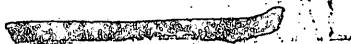

~~CONFIDENTIAL~~

USCINCPAC RECOVERY PLAN

h. (U) AKAC-874. Pacific Numeral Cipher/Authentication System (See USPACOM Code Systems for definition).



~~CONFIDENTIAL~~

~~CONFIDENTIAL~~
~~CONFIDENTIAL~~

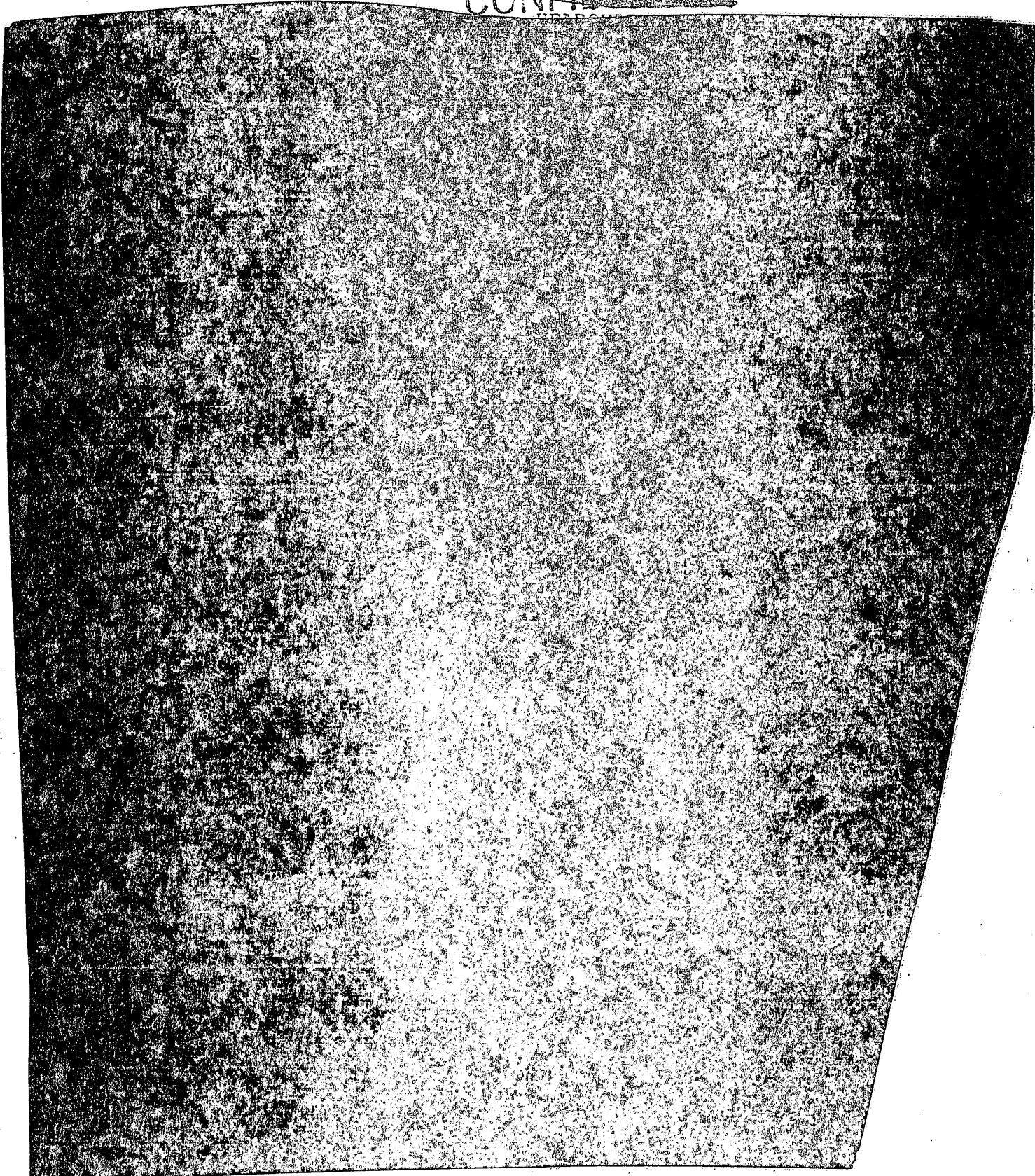

K-3-1

~~CONFIDENTIAL~~

~~CONFIDENTIAL~~

JSCINCPAC RECOVERY PLAN

(U) State Department Regional Points of Contact:

<u>AREA</u>	<u>POINT OF CONTACT</u>
Western Hemisphere	Chief, Regional Relay Facility Brandy, Virginia Routing Indicator: RUESC
Europe	Area Telecommunications Officer American Embassy, London Routing Indicator: RUDTC
Middle East	Area Telecommunications Officer American Embassy, Athens Routing Indicator: RUESAT
Pacific	Area Telecommunications Officer American Embassy, Manila Routing Indicator: RUMJMA
Southern Asia	Area Telecommunications Officer American Embassy, New Delhi Routing Indicator: RUSBAE
Africa South of Sahara	Area Telecommunications Officer American Embassy, Monrovia Routing Indicator: RUTAMA

K-3-2

~~CONFIDENTIAL~~
(This page is UNCLASSIFIED)

~~CONFIDENTIAL~~

HEADQUARTERS
COMMANDER IN CHIEF, US PACIFIC COMMAND
CAMP H. M. SMITH, HI 96861

11 June 1984

APPENDIX 4 TO ANNEX K TO USCINCPAC RECOVERY PLAN (U)
MRF COMMUNICATIONS REQUIREMENTS (U)

1. (U) GENERAL

a. (U) Throughout the various phases of this plan from initial alert to redeployment of forces, USCINCPAC must maintain secure communications with the MRF and the NMCC. COMSEC and OPSEC requirements dictate the use of secure voice, if possible.

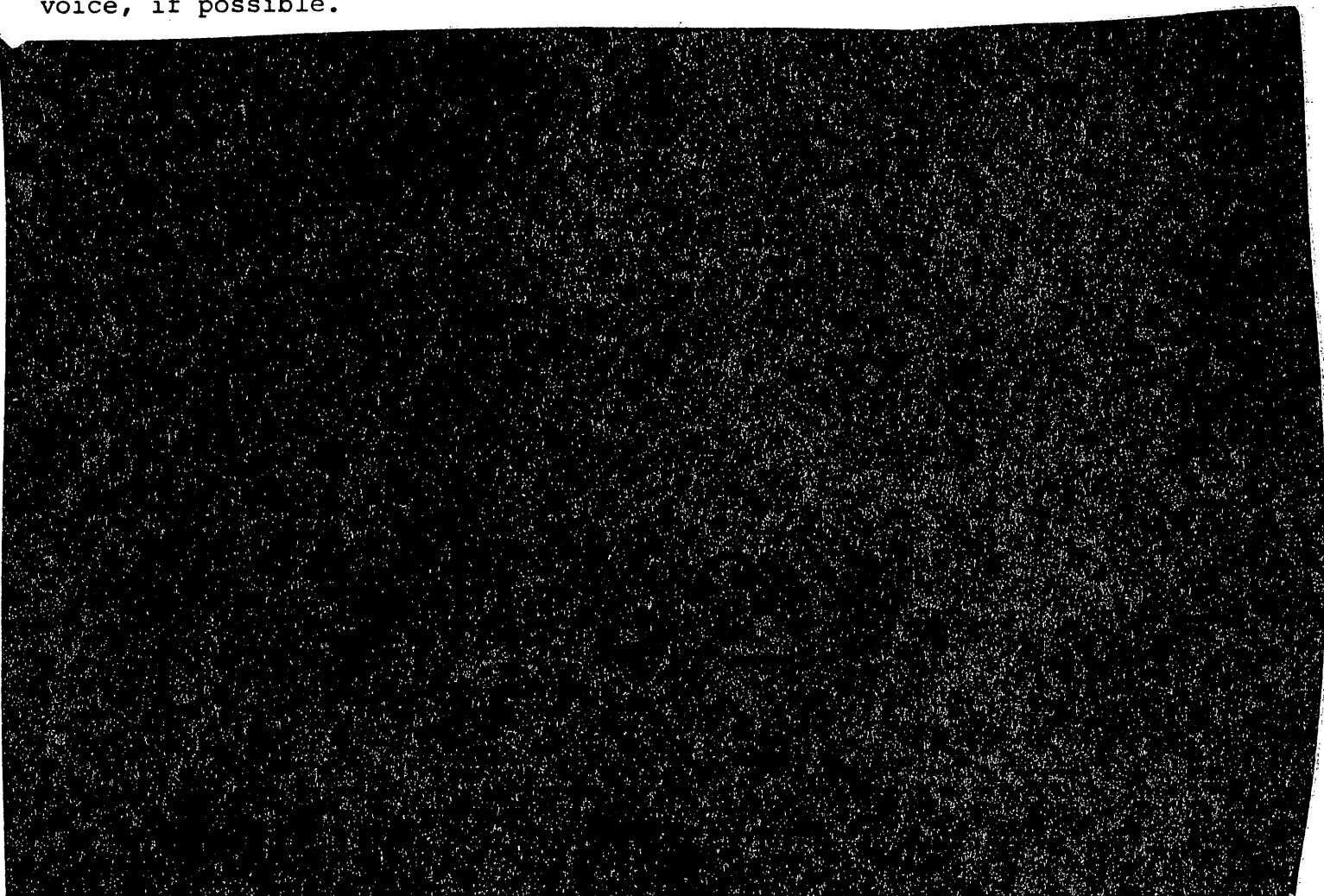

CLASSIFIED BY: DEPUTY CHIEF OF STAFF
DECLASSIFY ON: OADR

R-4-1

~~CONFIDENTIAL~~



f. (U) Other means of communications may be installed as time permits.

3. (U) JCSE MINIMUM EQUIPMENT REQUIREMENTS

<u>ITEM</u>	<u>QUANTITY</u>
AN/URC-56 (JACC/CP)	1
AN/WSC-3 Terminal	4
QRE Teams	2
KY-65	6
DACOM Secure Facsimile	1

TABS:

- A - MRF Marshaling Area and ISA/Rehearsal Area Communications
- B - MRF Base Communications
- C - MRF Objective Area Communications

~~CONFIDENTIAL~~

HEADQUARTERS
COMMANDER IN CHIEF, US PACIFIC COMMAND
CAMP H. M. SMITH, HI 96861
11 June 1984

TAB A TO APPENDIX 4 TO ANNEX K TO USCINCPAC RECOVERY PLAN (U)
MRF MARSHALING AREA AND ISA/REHEARSAL AREA COMMUNICATIONS (U)

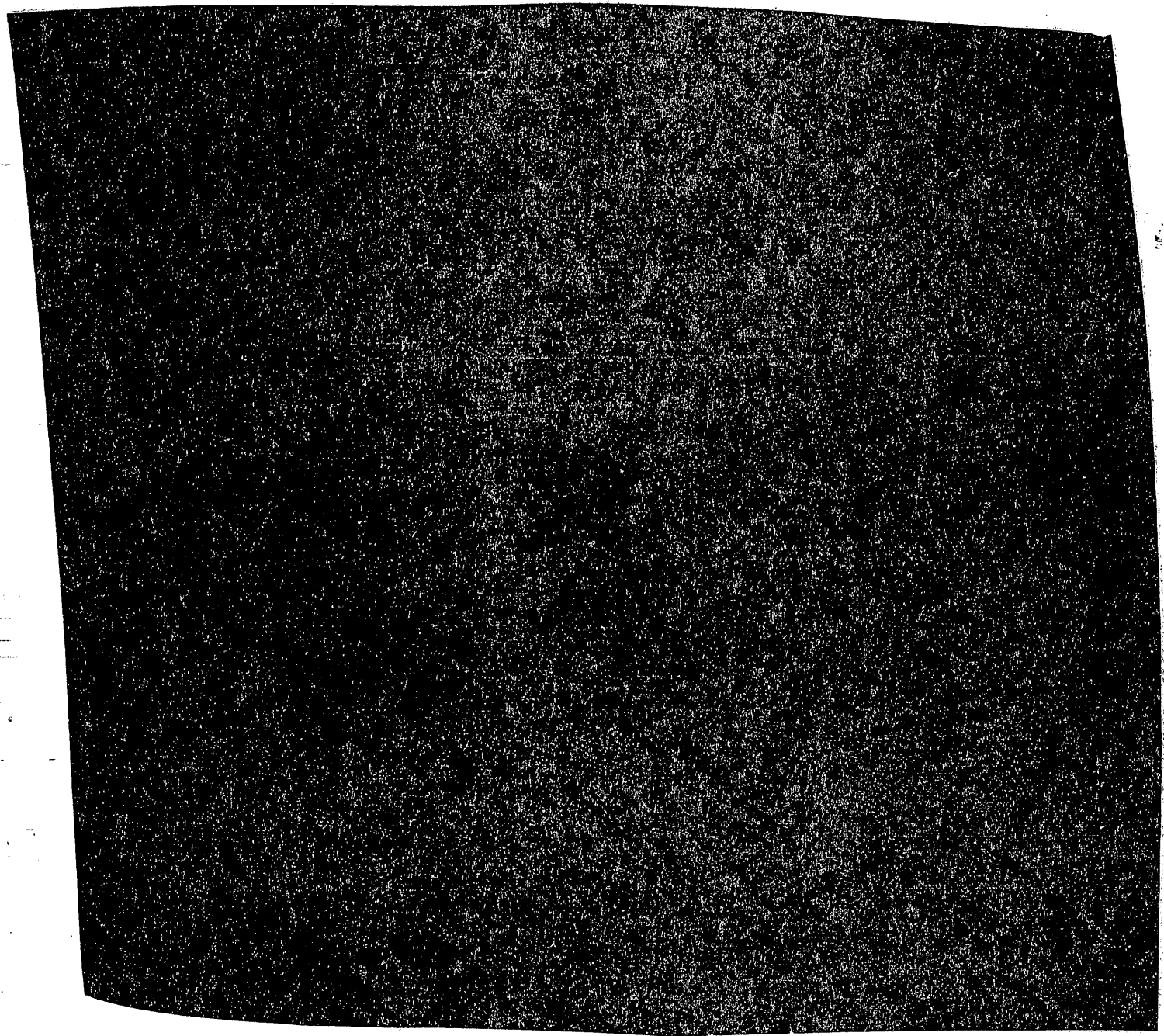

CLASSIFIED BY: DEPUTY CHIEF OF STAFF
DECLASSIFY ON: OADR

4-A-1

~~CONFIDENTIAL~~

~~CONFIDENTIAL~~

USCINCPAC RECOVERY PLAN

(THIS PAGE INTENTIONALLY LEFT BLANK)

K-4-A-2

~~CONFIDENTIAL~~

(This page is UNCLASSIFIED)

~~CONFIDENTIAL~~

HEADQUARTERS
COMMANDER IN CHIEF, US PACIFIC COMMAND
CAMP H. M. SMITH, HI 96861
11 June 1984

TAB B TO APPENDIX 4 TO ANNEX K TO USCINCPAC RECOVERY PLAN (U)
MRF BASE COMMUNICATIONS (U)

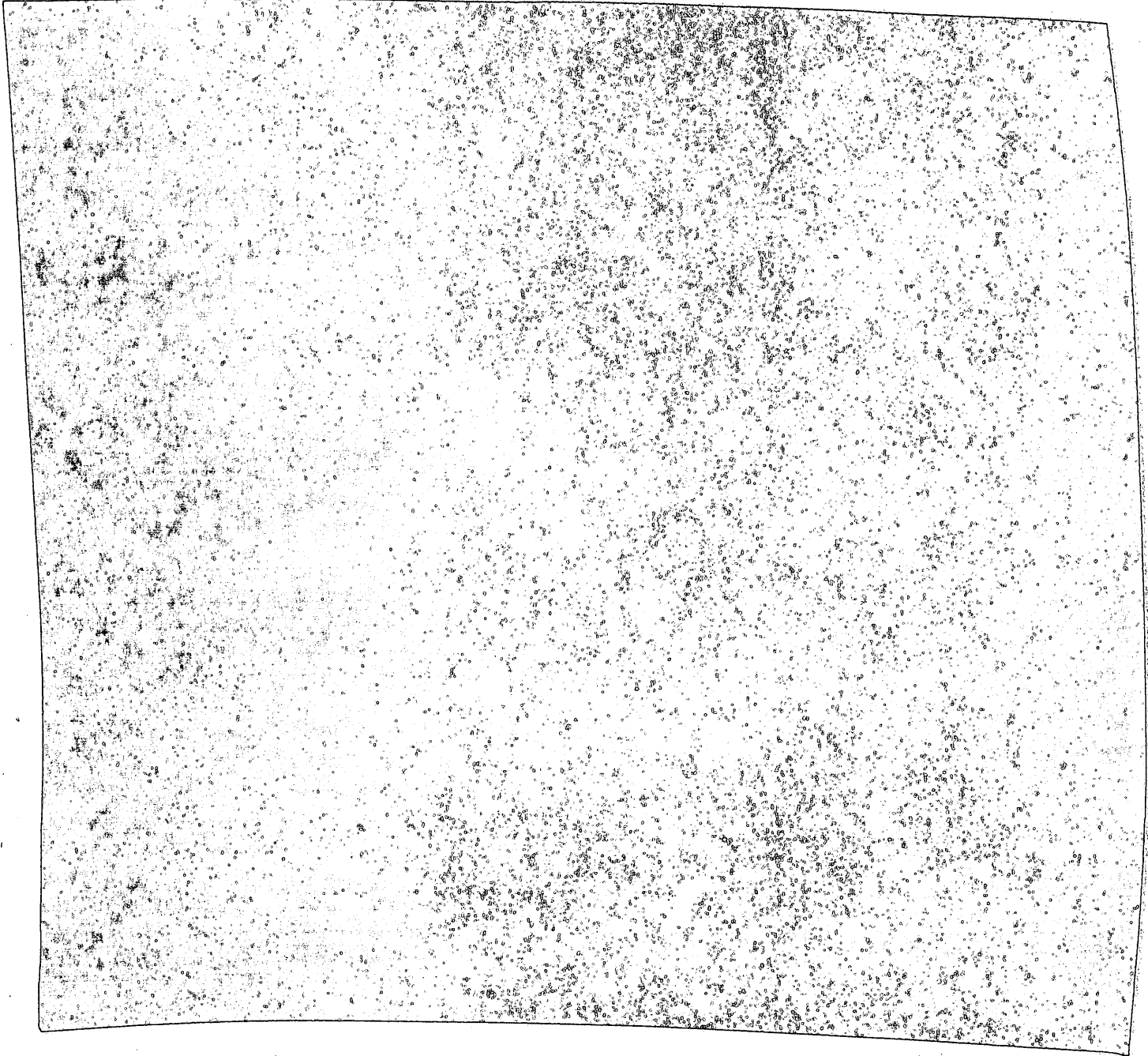

CLASSIFIED BY: DEPUTY CHIEF OF STAFF
DECLASSIFY ON: OADR

K-4-B-1

~~CONFIDENTIAL~~

~~CONFIDENTIAL~~

USCINCPAC RECOVERY PLAN

(THIS PAGE INTENTIONALLY LEFT BLANK)

K-4-3-2

~~CONFIDENTIAL~~

(This page is UNCLASSIFIED)

~~CONFIDENTIAL~~

HEADQUARTERS
COMMANDER IN CHIEF, US PACIFIC COMMAND
CAMP H. M. SMITH, HI 96861
11 June 1984

TAB C TO APPENDIX 4 TO ANNEX K TO USCINCPAC RECOVERY PLAN (U)
MRF OBJECTIVE AREA COMMUNICATIONS (U)

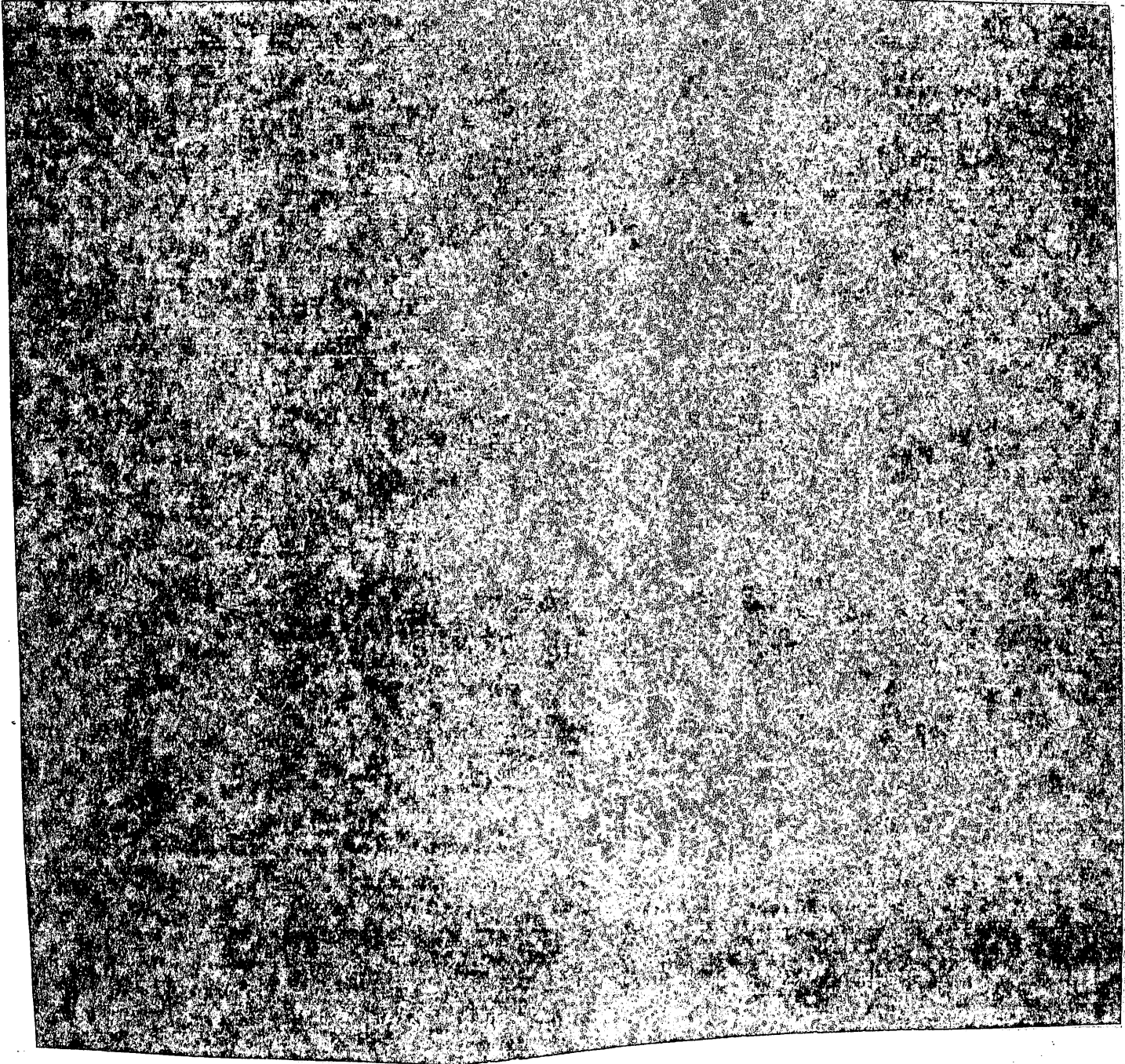

CLASSIFIED BY: DEPUTY CHIEF OF STAFF
DECLASSIFY ON: OADR

R-1-C-1

~~CONFIDENTIAL~~

~~CONFIDENTIAL~~

USCINCPAC RECOVERY PLAN

(THIS PAGE INTENTIONALLY LEFT BLANK)

K-4-C-2

~~CONFIDENTIAL~~

(This page is UNCLASSIFIED)

~~SECRET~~
HEADQUARTERS
COMMANDER IN CHIEF, US PACIFIC COMMAND
CAMP H. M. SMITH, HI 96861

11 June 1984

APPENDIX 5 TO ANNEX K TO USCINCPAC RECOVERY PLAN (U)
USCINCPAC CRISIS SITUATION COMMAND AND CONTROL COMMUNICATIONS (U)

1. (U) GENERAL

a. (U) This Appendix depicts USCINCPAC command and control communications for execution of military operations during crisis situations within USPACOM.

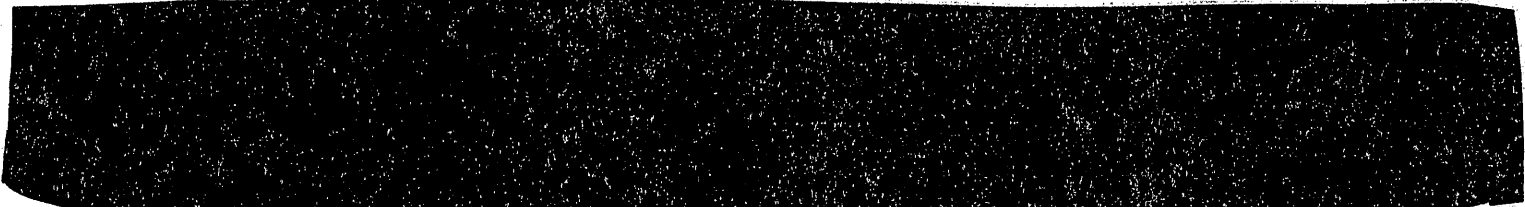

2. (U) USCINCPAC CRISIS SITUATION COMMAND AND CONTROL COMMUNICATIONS

a. (U) System Concept. Crisis situation command and control communications will employ the following systems within existing capabilities:



CLASSIFIED BY: DEPUTY CHIEF OF STAFF
DECLASSIFY ON: OADR

K-5-1

~~SECRET~~

(This page is CONFIDENTIAL)

~~CONFIDENTIAL~~
~~CONFIDENTIAL~~

b. (U) Communications Procedures

(1) (U) Secure Voice Command Net

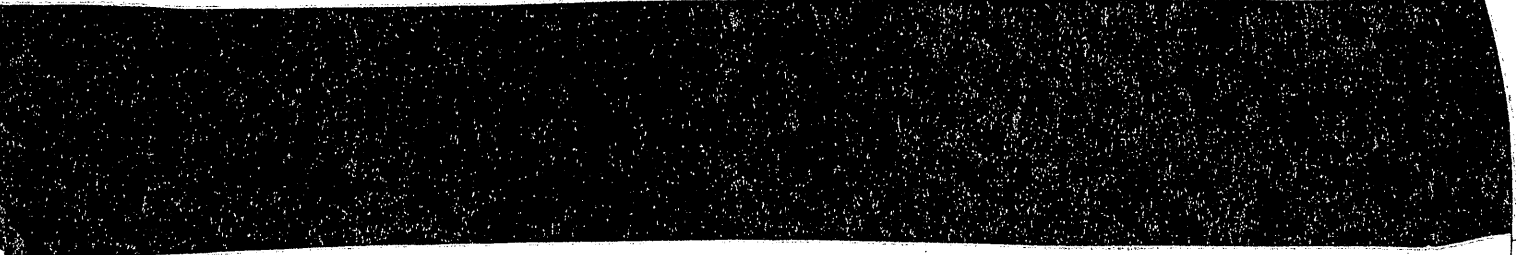

(c) (U) AN/FTC-31 switch will be the technical net control and will insure technical voice quality of individual conferees prior to passing control to operational net control (originator).

(d) (U) When all requested conferees are in the conference, the originator will be so informed and placed in the conference. The technical net control will at that time relinquish the conference control to the originator.

(e) (U) If a delay is experienced in bringing a conferee into the conference, the originator will be so notified and will advise the technical net control if the conference is to be delayed until all designated subscribers can be conferenced.

(f) (U) During the conference activation, the technical net control is responsible for circuit configuration and SECORD locations will be responsive to that direction.



(2) (U) Secure Voice Operations Net

net. (a) (U) The best quality remaining circuit will be used for this

net. (b) (U) Activation will be the same as for the secure voice command

(c) (U) Activation will be concurrent with the secure voice command net, however, the command net activation takes precedence.



(3) (U) Secure Teletype (OPSCOM) Net

(a) (U) Existing USPACOM AUTOCONET circuits will be conferenced by this headquarters as directed by the USCINCPAC Command Center. USCINCPAC Command Center will be net control. The AUTOCONET can send and receive simultaneously to pass all-source information vertically and laterally on a near real-time basis. The network uses the AUTODIN as the means to connect the terminals, and all stations may be conferenced at the same time or messages may be sent between individual stations at up to Flash precedence. AUTOCONET subscribers are NMCC, USCINCPAC, CINCPACFLT, CINCPACAF, CDRWESTCOM, COMUSKOREA, COMUSJAPAN, 314 AD, CDR 13AF, COMSEVENTHFLT (USS BLUE RIDGE) and Alaskan Air Command. The NMCC terminal will be operational full time, but manned only during a crisis.

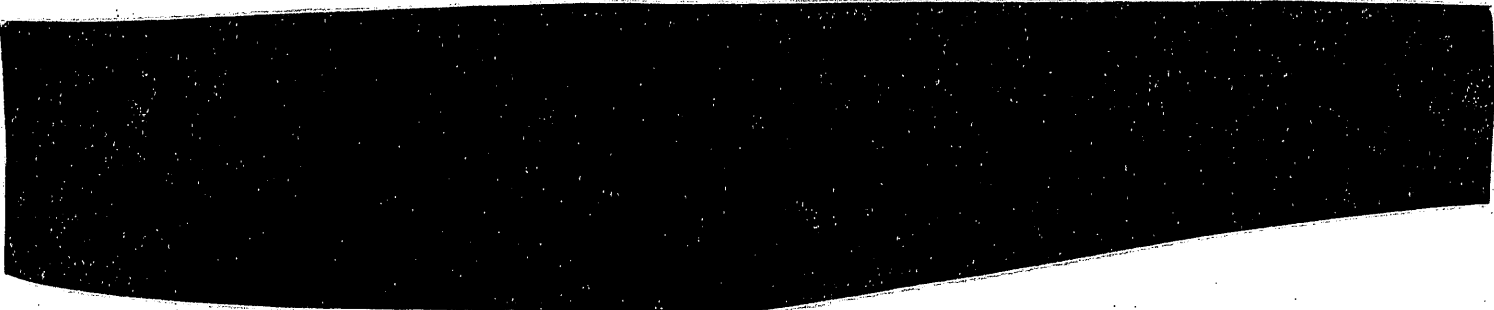

~~CONFIDENTIAL~~

USCINCPAC RECOVERY PLAN

(THIS PAGE INTENTIONALLY LEFT BLANK)

K-5-4

~~CONFIDENTIAL~~
(This page is UNCLASSIFIED)

~~SECRET~~

HEADQUARTERS
COMMANDER IN CHIEF, US PACIFIC COMMAND
CAMP H. M. SMITH, HI 96861
11 June 1984

ANNEX L TO USCINCPAC RECOVERY PLAN (U)
OPERATIONS SECURITY (U)

(U) REFERENCE: (a) JCS PUB 18, Operations Security

1. (U) GENERAL

a. (U) Definitions

(1) (U) Operations Security. The process of denying adversaries information about friendly capabilities and intentions by identifying, controlling, and protecting indicators associated with planning, conducting military operations and other activities.

(2) (U) Essential Elements of Friendly Information. Key questions about friendly intentions and military capabilities likely to be asked by opposing planners and decision-makers.

(3) (U) Appreciations. Assumptions, estimates, and facts about an opponent's intentions and military capabilities used in planning and decision-making.

(4) (U) OPSEC Indicators. Actions or information, classified or unclassified, obtainable by an adversary that would result in adversary appreciations and actions harmful to achieving friendly intentions and preserving friendly military capabilities.

b. (U) Mission. When directed by USCINCPAC, the responsible or designated service component commander or subordinate unified commander will deploy sufficient forces to assist in the location and recovery of a lost, seized or stolen nuclear weapon and return same to secure storage under DOD auspices.

2. (U) TASKS

a. (U) Each USCINCPAC subordinate command will, in accordance with reference (a), conduct a thorough OPSEC evaluation of the operations to be conducted and will:

CLASSIFIED BY: DEPUTY CHIEF OF STAFF
DECLASSIFY ON: OADR

~~SECRET~~

~~SECRET~~

USCINCPAC RECOVERY PLAN

(1) (U) Identify and implement OPSEC/cover measures in anticipation of a possible incident to insure secrecy of operations should an incident actually occur.

(2) (U) Prepare OPSEC/cover plans for execution should an actual incident occur.

(3) (U) Prepare OPSEC plans to insure secrecy during exercises, and exercise OPSEC/cover measures that would be used in an actual incident.

(4) (U) Execute OPSEC/cover measures to preserve secrecy during an actual incident.

b. (U) Based upon information provided by USCINCPAC subordinate commands, USCINCPAC will advise the Joint Chiefs of Staff of OPSEC/cover measures requiring national level execution or support.

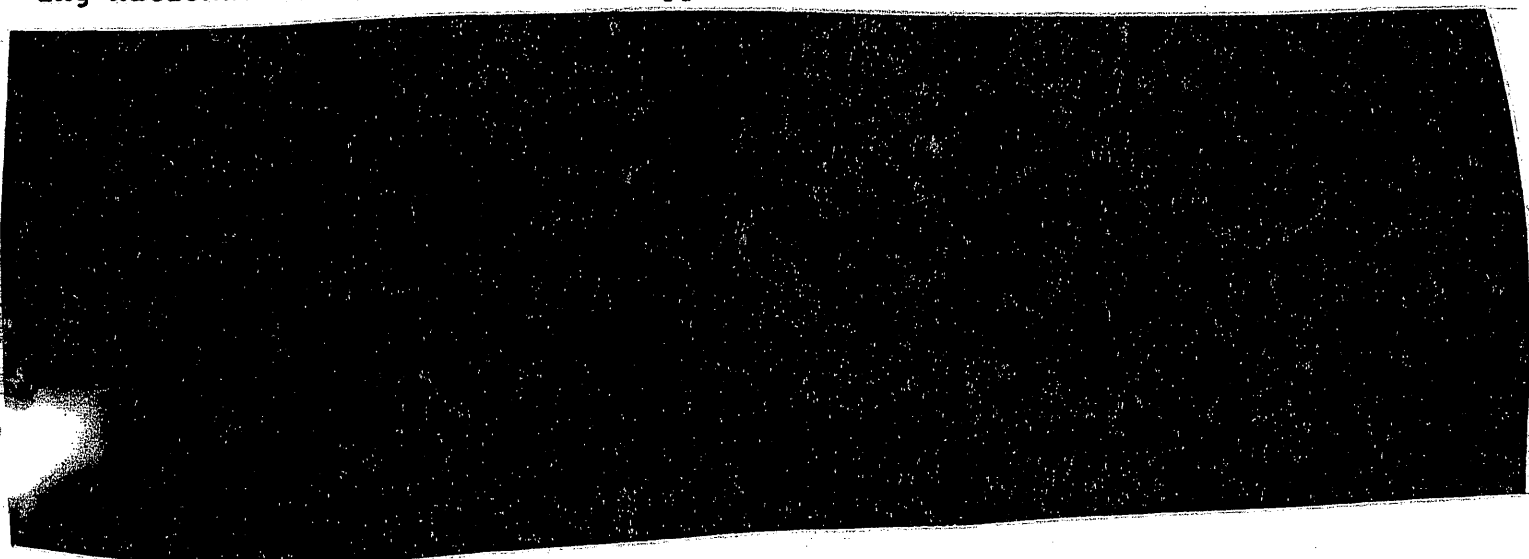

WILLIAM J. CROWE, JR.
Admiral
Commander in Chief

- Appendices:
1 - OPSEC Estimate
3 - Protective Measures

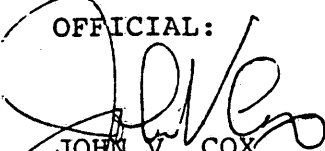
OFFICIAL:

JOHN V. COX
Major General
Director J-3

~~SECRET~~

~~CONFIDENTIAL~~
HEADQUARTERS
COMMANDER IN CHIEF, US PACIFIC COMMAND
CAMP H. M. SMITH, HI 96861
11 June 1984

APPENDIX 1 TO ANNEX L TO USCINCPAC RECOVERY PLAN (U)
OPSEC ESTIMATE (U)

2. (U) ESSENTIAL ELEMENTS OF FRIENDLY INFORMATION

- a. (U) What US sensor capabilities exist to detect nuclear materials? How are they deployed? Who controls their capabilities?
- b. (U) What is US knowledge of terrorist groups? What level of cooperation exists among US agencies that track terrorist groups? How quickly is information exchanged/provided the United States?
- c. (U) What are US and allied capabilities to track trucks, aircraft, and ships/boats and determine quickly the legitimacy of cargo?
- e. (U) What US and friendly forces are likely to be tasked to train and prepare for nuclear weapons recovery missions? How will they be commanded and what communications nets will be used to control them? What commanders will be involved? What indicators are provided by patterns/volumes of communications (including telephone calls) that nuclear weapons have been located and that forces are deploying?
- f. (U) Where can explosive ordnance disposal (EOD) personnel come from? How skilled are they at handling nuclear weapons? What indicators show EOD personnel are readying for movement? Have they deployed?

CLASSIFIED BY: DEPUTY CHIEF OF STAFF
DECLASSIFY ON: OADR

~~CONFIDENTIAL~~
~~CONFIDENTIAL~~

USCINCPAC RECOVERY PLAN

(THIS PAGE INTENTIONALLY LEFT BLANK)

L-1-2

~~CONFIDENTIAL~~

(This page is UNCLASSIFIED)

~~CONFIDENTIAL~~
~~CONFIDENTIAL~~

HEADQUARTERS
COMMANDER IN CHIEF, US PACIFIC COMMAND
CAMP H. M. SMITH, HI 96861
11 June 1984

APPENDIX 3 TO ANNEX L TO USCINCPAC RECOVERY PLAN (U)
PROTECTIVE MEASURES (U)

1. (U) Actions that are logically to be expected in a crisis should be carried out in a normal manner.



3. (U) Explosive ordnance disposal (EOD) personnel in multiple locations should be prepared overtly for movement. The actual EOD personnel to be used should make covert preparations. Consideration should be given to making multiple preparatory movements with overt announcements and a tie in to the peaceful recovery.

4. (U) Intelligence collection efforts should focus on multiple areas. No announcements about the success of search efforts should be made. If success is realized, then intelligence collection should continue and no detectable activities executed that might reveal US knowledge.

5. (U) Measures to prepare, deploy, and use forces must be covered. This includes combat forces, nuclear emergency search teams, EOD, medical, and transportation capabilities as well as other assets that might be used.

6. (U) Operations into countries where national forces may oppose US recovery actions or where the theft was carried out by that nation should use OPSEC and deception measures suitable for combat operations.



CLASSIFIED BY: DEPUTY CHIEF OF STAFF
DECLASSIFY ON: OADR

~~CONFIDENTIAL~~
~~CONFIDENTIAL~~

~~CONFIDENTIAL~~

USCINCPAC RECOVERY PLAN

(THIS PAGE INTENTIONALLY LEFT BLANK)

L-3-2

~~CONFIDENTIAL~~
(This page is UNCLASSIFIED)

~~SECRET~~

HEADQUARTERS
COMMANDER IN CHIEF, US PACIFIC COMMAND
CAMP H. M. SMITH, HI 96861
11 June 1984

ANNEX X TO USCINCPAC RECOVERY PLAN (U)
EXECUTION CHECKLIST (U)

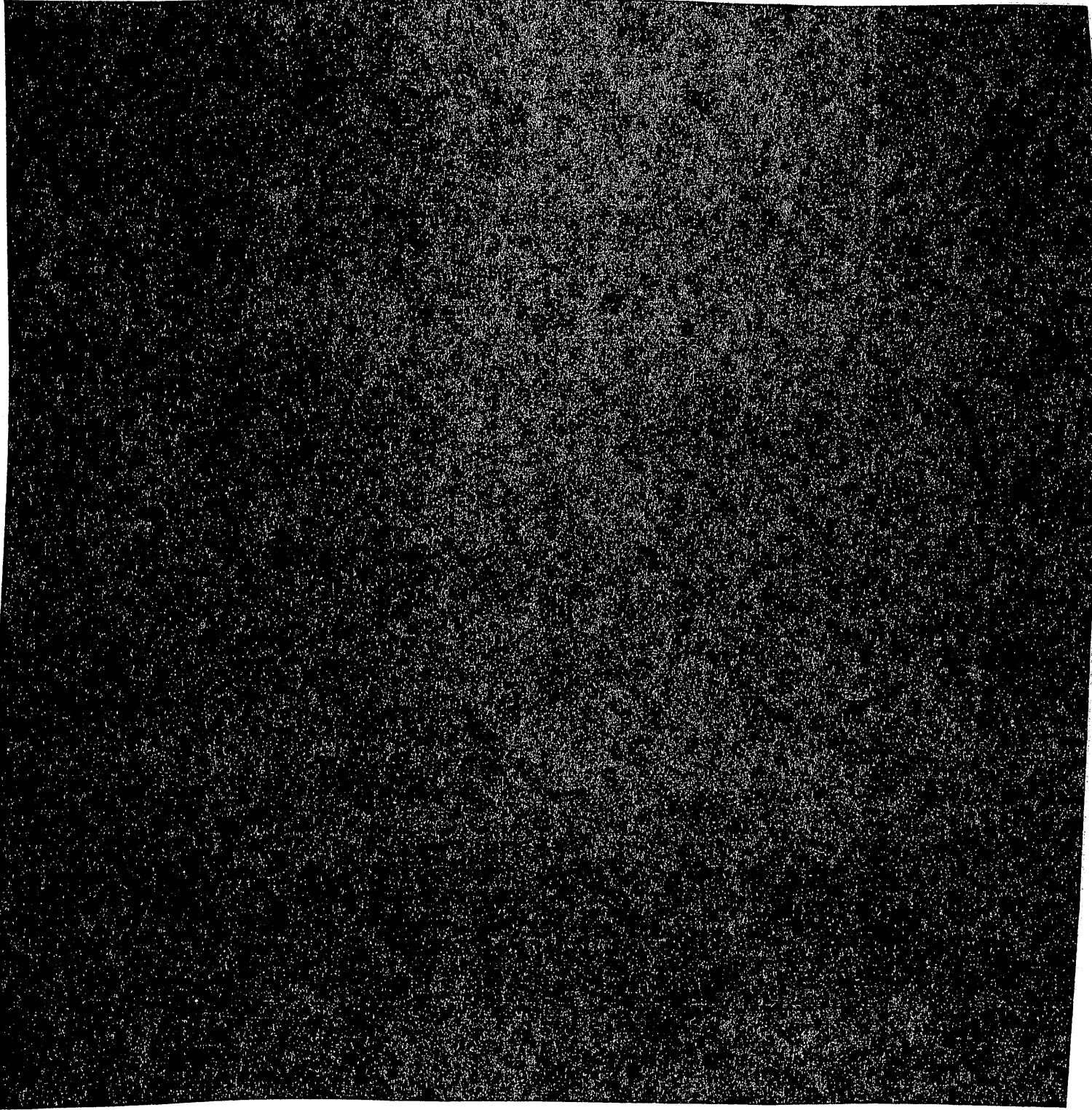

~~SECRET~~

~~SECRET~~

ACTION	HEADQUARTERS/ AGENCY	TIMING
--------	-------------------------	--------

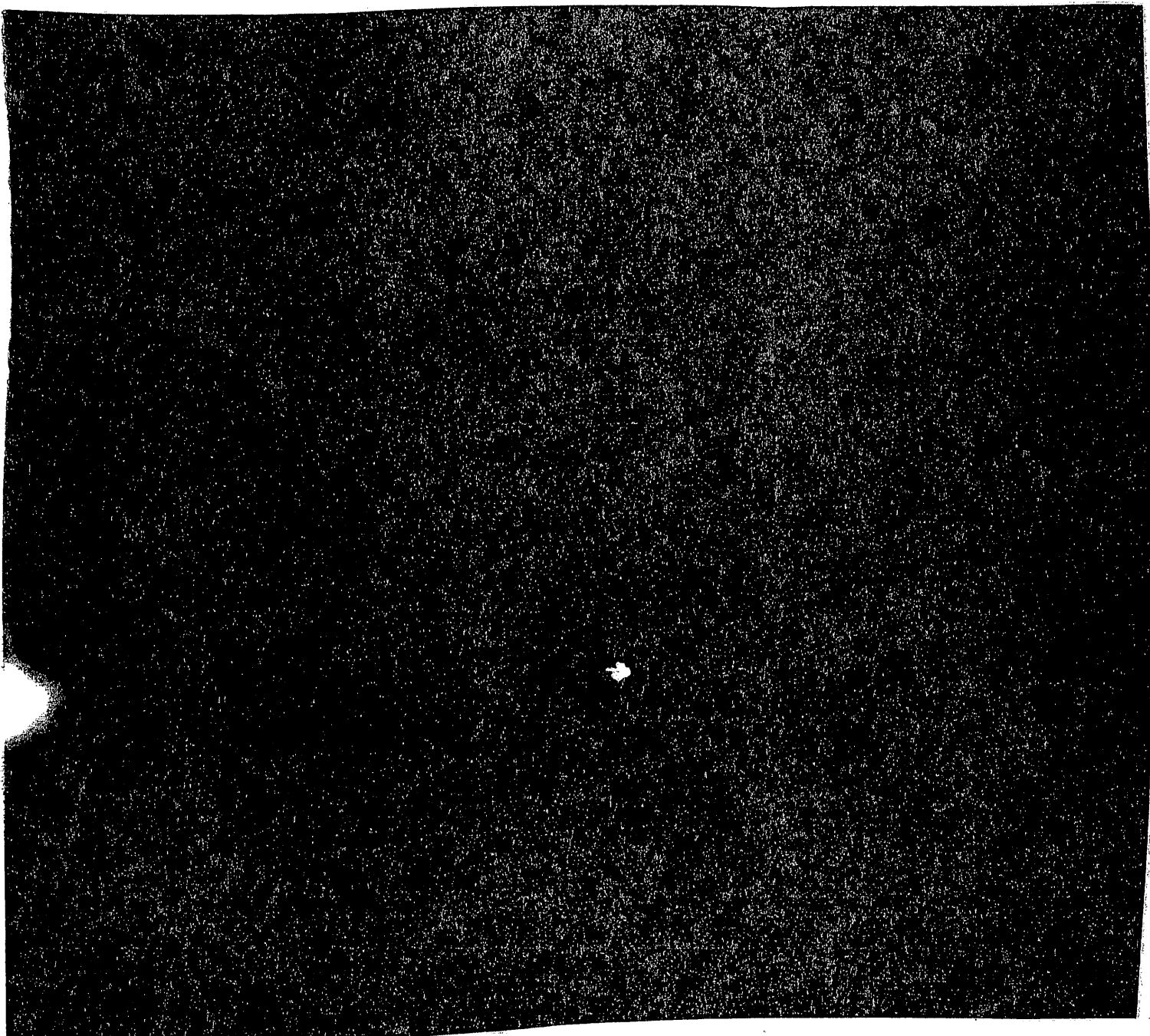

~~SECRET~~

~~SECRET~~

USCINCPAC RECOVERY PLAN

ACTION

HEADQUARTERS/
AGENCY

TIMING

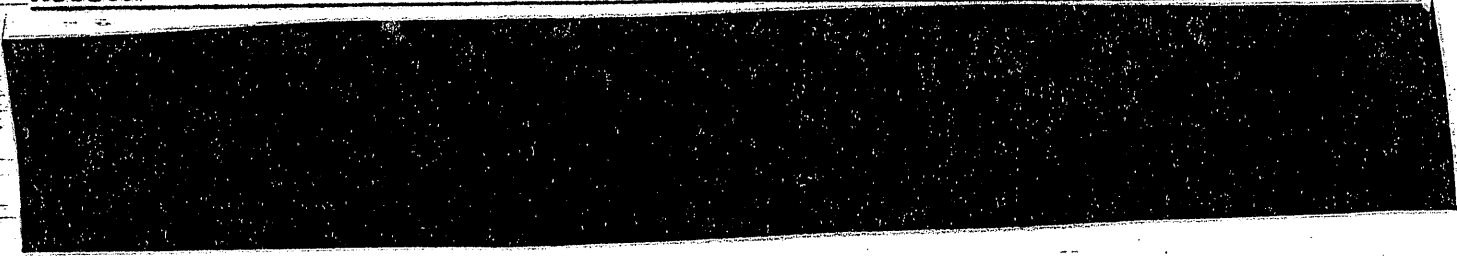

~~SECRET~~

~~SECRET~~

USCINCPAC RECOVERY PLAN

(THIS PAGE INTENTIONALLY LEFT BLANK)

X-4

~~SECRET~~

(This page is UNCLASSIFIED)

UNCLASSIFIED

HEADQUARTERS
COMMANDER IN CHIEF, US PACIFIC COMMAND
CAMP H. M. SMITH, HI 96861
11 June 1984

ANNEX 2 TO USCINCPAC RECOVERY PLAN (U)
DISTRIBUTION LIST

<u>Distribution</u>	<u>No. copies</u>	<u>Copy no.</u>
JCS	15	1-15
USCINCEUR	1	16
USCINCLANT	1	17
USCINCCENT	1	18
USCINCSO	1	19
CINCSAC	1	20
CINCMAC	1	21
CINCPACFLT	10	22-31
CINCPACAF	10	32-41
CDRWESTCOM	10	42-51
COMUSKOREA	5	52-56
COMUSJAPAN	5	57-61
USCINCPACREP GUAM/TTPI	1	62
USCINCPACREP PHIL	1	63
COMSOPAC	1	64
USCINCPACREP AUSTRALIA	1	65
USCINCPACREP ALEUTIANS	1	66
USCINCPACREP IO	1	67
USCINCPACREP SWPAC	1	68
JUSMAGTHAI	1	69
OMADP INDONESIA	1	70
USCINCPAC STAFF		
J2	1	71
J3	1	72
J4	1	73
J5	1	74
C3S	1	75
USDAO BANGLADESH	1	76
USDAO BURMA	1	77
USDLO HONG KONG	1	78
USDAO MALAYSIA	1	79
USDAO NEPAL	1	80
USDAO INDIA	1	81
USDAO NEW ZEALAND	1	82
USDAO SINGAPORE	1	83
USDAO SRI LANKA	1	84

UNCLASSIFIED

UNCLASSIFIED

USCINCPAC RECOVERY PLAN

(THIS PAGE INTENTIONALLY LEFT BLANK)

UNCLASSIFIED